



**AKRON**<sup>®</sup>  
BRASS COMPANY

# List Price Guide

Effective: January 5, 2015

All Prices in U.S. Dollars.

(Prices are for U.S. domestic resale and do not include International Tariffs, Taxes and Shipping.)

Supersedes All Previous Prices

**AKRON<sup>®</sup> BRASS COMPANY**  
**TERMS AND CONDITIONS**

**TERMS:** All U.S. sales are Net 30 days. All International sales are ex-factory or D.D.U. (Delivered Duty Unpaid) foreign port of destination. Subject to late payment charge of one and one-half percent (1½%) per month.

**MINIMUM CHARGE:** Due to cost of handling, no order will be billed for less than fifty dollars (\$50.00) - plus forwarding charges.

**SPECIAL ORDERS:** We produce many items to specification that are not carried in stock. After an order in this category has been accepted and placed in process of manufacture, no cancellations will be accepted.

**RETURNED GOODS:** Material returned without prior Returned Material Authorization may be refused. Please contact Akron Brass Customer Service Department for the proper procedure. All returns are subject to a 25% restocking charge. All products must meet current design specifications and must be received in like new condition to avoid rework charges.

**PRODUCT REPAIRS:** Products returned for repair do not require prior authorization. However, you can register the items you wish to return for repair at [www.akronbrass.com/online\\_repair](http://www.akronbrass.com/online_repair). This site will register the item to be sent back for repair, print the correct return address label, and allow you to track your repair status. Should you be unable to register on our website you can still send your items in need of repair without registering them first. Products for repair should be shipped to: Akron Brass Co., Attention Repair Department, 1615 Old Mansfield Road, Wooster, OH 44691. Extend-a-Lite<sup>®</sup> products and other related materials should be sent to Akron Brass Co., 501 N. Cummings Lane, Washington, IL 61571-9652. If you have any questions on where you should send your repairs, call Customer Service at: 800.228.1161 or 330.264.5678.

**PIKE POLE FREIGHT:** All Pike Pole & Hand Tool Purchases are F.O.B. factory regardless of discount structure. Freight Free shipments of Pike Poles can be obtained with a minimum order for a single shipment to one location of \$950.00 net cost. Does not apply to any International order.

**DISCREPANCIES:** Any shortage or error in shipment should be reported to us within 10 days of receipt of goods.

**LOST GOODS IN TRANSIT:** Any claims for loss of truck shipments shall be the responsibility of the buyer and should be promptly reported to carrier. Any claims for loss of small package shipments should be promptly reported to Akron Brass. These claims are subject to limitations of the carrier.

**DAMAGED GOODS:** Damaged product must be promptly reported to the carrier and Akron Brass. Failure to notify both parties shall place the burden of settlement and negotiation on the buyer. Damaged product returned to Akron Brass should be sent by the same carrier that delivered the goods.

**TAXES:** All prices and quotations exclude Local, State, and Federal sales and excise taxes.

**ALL ORDERS** or parts thereof and all directions for shipment are subject to acceptance by Akron Brass Company.

**ALL PRICES ARE FIRM PROVIDED IMMEDIATE DELIVERY IS ACCEPTABLE.**

**ALL PRICES, TERMS, AND CONDITIONS ARE SUBJECT TO CHANGE WITHOUT NOTICE.**

**WARRANTY AND DISCLAIMER:** We warrant Akron Brass products for a period of five (5) years\* after purchase against defects in materials or workmanship. Akron Brass will repair or replace product which fails to satisfy this warranty. Repair or replacement shall be at the discretion of Akron Brass. Products must be promptly returned to Akron Brass for warranty service. We will not be responsible for: wear and tear; any improper installation, use, maintenance or storage; negligence of the owner or user; repair or modification after delivery; damage; failure to follow our instructions or recommendations; or anything else beyond our control. **WE MAKE NO WARRANTIES, EXPRESS OR IMPLIED, OTHER THAN THOSE INCLUDED IN THIS WARRANTY STATEMENT, AND WE DISCLAIM ANY IMPLIED WARRANTY OF MERCHANTABILITY OR FITNESS FOR ANY PARTICULAR PURPOSE.** Further, we will not be responsible for any consequential, incidental or indirect damages (including, but not limited to, any loss of profits) from any cause whatsoever. No person has authority to change this warranty.

**CERTIFICATE OF CONFORMANCE:** Many commercial products are available with certificate of conformance to MIL specifications. If a certificate of conformance is required, it must be requested at the time order is placed and is subject to additional charges to cover the costs of the special handling required.

**DOMESTIC DISTRIBUTORS/DEALERS ONLY:**

**PRODUCTS ARE INTENDED FOR DOMESTIC RESALE. AKRON BRASS RESERVES THE RIGHT TO RESTRICT DOMESTIC SALES OF PRODUCTS INTENDED FOR INTERNATIONAL DIVERSIONS. CONTACT AKRON BRASS FOR AUTHORIZATION BEFORE COMMITTING TO ANY INTERNATIONAL SHIPMENTS.**

**INTERNATIONAL DISTRIBUTORS/DEALERS ONLY:**

**PRODUCTS ARE LICENSED BY THE U.S.A. FOR EXPORT AND INTERNATIONAL RESALE EXCEPT FOR DIVERSIONS OR SALES INTO AREAS CONTRARY AND PROHIBITED BY U.S. LAW G.D.E.S.T.**

*Items noted with a "★" are subject to a non-standard distributor discount.*

*Items noted with a "◇" are subject to a \$68.00 per inlet upcharge if fitted with British Instantaneous (BIM or BIF), Japanese Instantaneous (JIM or JIF), or Storz connections*

\* Various products have an extended 10 year warranty. All Industrial electronic warranties are limited to 1 year.  
© 2014 Premier Farnell Corporation. All rights reserved. Akron and the Akron Logo are trademarks of Premier Farnell Corporation.



# PRICE GUIDE INDEX

STYLES 4 - 335 .....	1
STYLES 336 - 354 .....	2
STYLES 354 - 449 .....	3
STYLES 485 - 1078 .....	4
STYLES 1088 - 1496 .....	5
STYLES 1499 - 1615 .....	6
STYLES 1616 - 2047 .....	7
STYLES 2055 - 2441 .....	8
STYLES 2442 - 3293 .....	9
STYLES 3293 - 3405 .....	10
STYLES 3406 - 3440 .....	11
STYLES 3443 - 3480 .....	12
STYLES 3480 - 3571 .....	13
STYLES 3572 - 3771 .....	14
STYLES 3778 - 4813 .....	15
STYLES 4814 - 5071 .....	16
STYLES 5075 - 6051 .....	17
STYLES 7592 - 9132 .....	18
STYLES 9145 - 9900 .....	19
SWING-OUT™ VALVES & ACCESSORIES .....	20
SWING-OUT™ VALVE HANDLES & ADAPTERS .....	21
SWING-OUT™ VALVE ADAPTERS .....	22 - 30
SWING-OUT™ VALVE ADAPTERS & BUTTERFLY VALVES .....	31
FLOW TESTING EQUIPMENT .....	32
HAND TOOLS .....	32 - 33
Forcible Entry Tools .....	32
Pinch Point Bars .....	32
Axes and Sledge Hammers .....	33
Fire Brooms, Rakes, Shovels and Beaters .....	33
Wildland Tools .....	33
Super Spanner Wrenches .....	33
PIKE POLES .....	33 - 34
Roof Hooks and Gorilla Hooks .....	33
Pike Pole Configuration Chart .....	34
Ultra-Tough .....	34
Ultra-Lite .....	34
Double Gripper Ultra-Lite .....	34
I-Beam .....	34
Gripper .....	34
Double Gripper Oval Rod .....	34
Wood .....	34
Adapt-A-Pole .....	34
Pike Pole Mounting Brackets .....	34
EXTENDA-LITE® .....	35 - 36
Configuration Chart .....	35
Light Heads .....	35
Base and Pole Options .....	35
Bracket Options .....	35
Additional Options and/or Replacement Components .....	35 - 36
Dual Head Options .....	36
Replacement Lamps Only .....	36
Class 1, Div 2 Hazardous Location SceneStar™ Lights .....	36
GENERATORS & PUMPS .....	36
Honda Generators and Honda Light Kits .....	36
Honda Pumps .....	36
FIXED ELECTRIC REWIND REELS .....	37 - 38
Manual Booster Hose .....	37
Booster Hose .....	37
Hydraulic .....	37 - 38
Air .....	38
CORD REELS - PORTABLE MANUAL and FIXED ELECTRIC .....	38 - 39
CORD - GANG BOXES - PIGTAILS .....	39 - 40
JUNCTION BOX .....	40
RAPID FILL SYSTEM .....	40
JUNCTION BOX ORDER FORM .....	41 - 42
PLUGS & CONNECTORS .....	43
WELDON LIST PRICE GUIDE .....	45 - 70
V-MUX® .....	63 - 65



Style	Description	US\$ List Price
4	<i>3/4" Drain-It Drain Valve</i> .....	202.00
7	<i>3/4" Drain Valve</i> .....	150.00
10	<i>Universal Spanner Wrench</i> .....	39.00
13	<i>Brass Folding Pocket Spanner</i> .....	51.00
14	<i>Akrolite™ Folding Pocket Spanner</i> .....	49.00
15	<i>Hydrant and Spanner Wrench</i> .....	92.00
	Replacement Insert (P/N 104718) .....	★22.28
17	<i>Adjustable Hydrant Wrench</i> .....	75.00
19	<i>Universal Suction Spanner Wrench</i> .....	143.00
25	<i>Hole Type Spanner Wrench</i> Specify <i>3/4"-1"</i> or <i>2 1/2"</i> .....	39.00
31	<i>Pressure Gauge</i> .....	270.00
32	<i>Pressure Gauge</i> .....	270.00
35	<i>Line Gauge</i> <i>2 1/2"</i> (65 mm) .....	366.00
	<i>3"</i> (75 mm).....	682.00
36	<i>Pressure Gauge</i> .....	218.00
39	<i>Horizontal Tool Bracket 3/4" - 1"</i> .....	69.00
40	<i>Horizontal Tool Bracket 1 1/2" - 2 1/2"</i> .....	69.00
41	<i>Vertical Tool Bracket 3/4" - 1"</i> .....	69.00
42	<i>Vertical Tool Bracket 1 1/2" - 2 1/2"</i> .....	69.00
44	<i>Pressure - Vacuum Panel Adapter</i> .....	100.00
46	<i>Fitzall Combination Spanner</i> .....	45.00
50	<i>Trooper Bar</i> .....	153.00
57	<i>Quarter Turn Drain Valve</i> .....	111.00
59	<i>Intake Pressure Relief Valve</i> .....	623.00
70	<i>Leaf Thread Gauge</i> .....	109.00
75	<i>Expansion Units</i> <i>1"</i> (25 mm) with Drawbar .....	967.00
	<i>1 1/2"</i> (38 mm) with Drawbar.....	955.00
	<i>1 1/2" x 1 3/4"</i> (38 x 44 mm) with Drawbar.....	978.00
	<i>2"</i> (51 mm) with Drawbar .....	1,043.00
	<i>2 1/2"</i> (65 mm) with Drawbar.....	1,080.00
	<i>3" x 2 1/2"</i> (75 x 65 mm) with Drawbar .....	1,187.00
	<i>2 1/2" - 3"</i> (65 x 75 mm) Drawbar Only (P/N 7-08-044) .....	★277.70
	<i>4"</i> (102 mm) less Drawbar .....	1,233.00
	<i>4 1/2"</i> (114 mm) less Drawbar.....	1,376.00
	<i>5"</i> (127 mm) less Drawbar.....	1,393.00
	<i>6"</i> (153 mm) less Drawbar .....	1,650.00
	<i>3 1/2" - 6"</i> (89 - 153 mm) Drawbar Only (P/N 7-08-059) .....	★344.77
78	<i>Hose and Ladder Strap</i> .....	92.00
90	<i>Die</i> <i>1 1/2"</i> (38 mm) .....	763.00
	<i>2 1/2"</i> (65 mm) .....	934.00

Style	Description	US\$ List Price
91	<i>Tap</i> <i>1 1/2"</i> (38 mm) .....	759.00
	<i>2 1/2"</i> (65 mm) .....	929.00
101	<i>3 1/2" Top-Mount Remote Control</i> .....	237.00
102	<i>5" Top-Mount Remote Control</i> .....	233.00
120	<i>HydroFX™ Flow Indicator Retrofit Kit</i> .....	496.00
	Compatible with the following Nozzles: 1442, 1443, 1446, 1615, 1616, 1722, 1723, 1725, 1726, 1733, 1736 1762, 1763, 2125, 2126, 2430, 2431, 2432, 2433, 4115, 4116, 4715, 4720, 4815, 4820, 4822, 4823, 4825, 4826, 4836, 4838, 4862, 4863	
260	<i>Plain Wye</i> <i>1 1/2"</i> F x (2) <i>1"</i> M (38 x 25 mm).....	417.00
	<i>1 1/2"</i> F x (2) <i>1 1/2"</i> M (38 x 38 mm).....	447.00
	<i>2 1/2"</i> F X (2) <i>1 1/2"</i> M (65 x 38 mm) .....	454.00
	<i>2 1/2"</i> F X (2) <i>2 1/2"</i> M (65 x 65 mm) .....	575.00
	<i>3"</i> F x (2) <i>2 1/2"</i> M (75 x 65 mm) .....	907.00
	<i>3 1/2"</i> F x (2) <i>2 1/2"</i> M (89 x 65 mm).....	973.00
	<i>4"</i> F x (2) <i>2 1/2"</i> M (102 x 65 mm).....	979.00
	<i>4 1/2"</i> F x (2) <i>2 1/2"</i> M (114 x 65 mm).....	1,092.00
	<i>5"</i> F x (2) <i>2 1/2"</i> M (127 x 65 mm).....	1,186.00
	<i>6"</i> F X (2) <i>2 1/2"</i> M (153 x 65 mm).....	1,380.00
261	<i>Plain Siamese</i> <i>2 1/2"</i> M x (2) <i>2 1/2"</i> F (65 x 65 mm).....	707.00
	<i>3"</i> M x (2) <i>2 1/2"</i> F (75 x 65 mm) .....	891.00
262	<i>Clapper Valve Siamese</i> <i>2 1/2"</i> M x (2) <i>2 1/2"</i> F (65 x 65 mm).....	1,158.00
	<i>3"</i> M x (2) <i>2 1/2"</i> F (75 x 65 mm) .....	1,287.00
266	<i>Clapper Valve Siamese</i> <i>3"</i> F x (2) <i>2 1/2"</i> F (75 x 65 mm).....	1,330.00
	<i>4"</i> F x (2) <i>2 1/2"</i> F (102 x 65 mm) .....	1,687.00
	<i>4 1/2"</i> F x (2) <i>2 1/2"</i> F (114 x 65 mm).....	1,807.00
	<i>5"</i> F x (2) <i>2 1/2"</i> F (127 x 65 mm).....	1,875.00
	<i>6"</i> F x (2) <i>2 1/2"</i> F (153 x 65 mm) .....	2,047.00
285	<i>Gate Valve</i> <i>2 1/2"</i> (65 x 65 mm).....	747.00
326	<i>British Instantaneous Adapter</i> <i>1 1/2"</i> M x <i>2 1/2"</i> BIM (38 x 38 mm) .....	137.00
	<i>2 1/2"</i> M x <i>2 1/2"</i> BIM (65 x 65 mm) .....	137.00
330	<i>Short Internal Lug Adapter</i> <i>1 1/2"</i> NPT F x <i>1 1/2"</i> M (38 x 38 mm).....	59.00
	<i>2 1/2"</i> NPT F x <i>2 1/2"</i> M (65 x 65 mm) Optional with strainer .....	89.00
	<i>3"</i> NPT F x <i>2 1/2"</i> M (75 x 65 mm) .....	246.00
	<i>3"</i> NPT F x <i>3"</i> M (75 x 75 mm).....	184.00
331	<i>Long Internal Lug Adapter</i> <i>2 1/2"</i> NPT F x <i>2 1/2"</i> M (65 x 65 mm).....	125.00
335	<i>Double Female Adapter</i> <i>1 1/2"</i> (38 mm).....	218.00
	<i>2"</i> (51 mm).....	221.00
	<i>2 1/2"</i> (65 mm) .....	256.00
	<i>3"</i> x <i>2 1/2"</i> (75 x 65 mm).....	652.00
	<i>3"</i> (75 mm).....	401.00

Style	Description	US\$ List Price			
		Pyrolite®	Cast	Chrome	
336	<b>Double Male Adapter</b>				
	1 1/2" (38 mm).....	158.00	132.00	146.00	
	2" x 1 1/2" (51 x 38 mm).....	196.00		249.00	
	2 1/2" x 1 1/2" (65 x 38 mm).....		164.00	243.00	
	2 1/2" (65 mm).....	158.00	188.00	188.00	
	3" (75 mm).....		320.00	448.00	
	3" x 2 1/2" (75 x 65 mm).....		338.00	97.00	
	3 1/2" (89 mm).....		537.00	664.00	
	4" (102 mm).....		658.00		
	337	<b>Rigid Female to Male Adapter</b>	Pyrolite®	Cast	Chrome
		3/4" GHT F x 1" M (19 x 25 mm).....	113.00		135.00
		1" F x 3/4" GHT M (25 x 19 mm).....		113.00	135.00
1" F x 1" M (25 x 25 mm).....			113.00	135.00	
1" F x 1 1/2" M (25 x 38 mm).....			119.00	144.00	
1 1/4" F x 1" M (32 x 25 mm).....			131.00	158.00	
1 1/2" F x 1" M (38 x 25 mm).....			119.00	144.00	
1 1/2" F x 1 1/2" M (38 x 38 mm).....			131.00	176.00	
1 1/2" F x 2" M (38 x 51 mm).....			159.00	195.00	
1 1/2" F x 2 1/2" M (38 x 65 mm).....			159.00	198.00	
2" F x 1 1/2" M (51 x 38 mm).....			137.00	190.00	
2" F x 2" M (51 x 51 mm).....			169.00	214.00	
2" F x 2 1/2" M (51 x 65 mm).....			229.00	264.00	
2 1/2" F x 3/4" GHT M (65 x 19 mm).....			140.00	193.00	
2 1/2" F x 1" M (65 x 25 mm).....			140.00	198.00	
2 1/2" F x 1 1/2" M (65 x 38 mm).....		112.00	144.00	144.00	
2 1/2" F x 2" M (65 x 51 mm).....			167.00	207.00	
2 1/2" F x 2 1/2" M (65 x 65 mm).....		148.00	190.00	245.00	
2 1/2" F x 3" M (65 x 75 mm).....			316.00	392.00	
2 1/2" F x 3 1/2" M (65 x 89 mm).....			395.00	508.00	
3" F x 1 1/2" M (75 x 38 mm).....			341.00	432.00	
3" F x 2 1/2" M (75 x 65 mm).....			325.00	395.00	
3" F x 3" M (75 x 75 mm).....			338.00	405.00	
3" F x 3 1/2" M (75 x 89 mm).....			455.00	589.00	
3 1/2" F x 2 1/2" M (89 x 65 mm).....		382.00	490.00		
3 1/2" F x 3" M (89 x 75 mm).....		490.00	630.00		
338	<b>Suction Lug Adapter</b>		Cast	Chrome	
	1 1/2" NPT F x 1 1/2" F (38 x 38 mm).....		178.00	217.00	
	2 1/2" NPT F x 2 1/2" F (65 x 65 mm).....		217.00	239.00	
	3" NPT F x 2 1/2" F (75 x 65 mm).....		333.00	310.00	
	3" NPT F x 3" F (75 x 75 mm).....			383.00	
	3" NPT F x 3 1/2" F (75 x 89 mm).....			514.00	
	3 1/2" NPT F x 3 1/2" F (89 x 89 mm).....			638.00	
	3 1/2" NPT F x 4" M (89 x 102 mm).....			917.00	
	4" NPT F x 3 1/2" F (102 x 89 mm).....			917.00	
	4" NPT F x 4" F (102 x 102 mm).....		679.00	723.00	
339	<b>Basket Suction Strainer</b>				
	2 1/2" NH (65 mm).....			266.00	
	5" NH (127 mm).....			484.00	
340	<b>Barrel Suction Strainer</b>				
	4" NH (102 mm).....			524.00	
	4 1/2" NH (114 mm).....			545.00	
	5" NH (127 mm).....			581.00	
	6" NH (153 mm).....			604.00	
344	<b>Barrel Suction Strainer</b>				
	2 1/2" NH (65 mm).....			261.00	
	3" NH (75 mm).....			327.00	

Style	Description	US\$ List Price		
		Cast	Chrome	
345	<b>Hose Cap with Rocker Lug</b>			
	3/4" GHT (19 mm).....	78.00	103.00	
	1" (25 mm).....		111.00	
	1 1/2" (38 mm).....	67.00	93.00	
	2" (51 mm) Available with long handle.....	111.00	133.00	
	2 1/2" (65 mm).....	111.00	135.00	
	3" (75 mm) Available with long handle.....	187.00	237.00	
	3 1/2" (89 mm).....		316.00	
	Add for Beaded Chain.....	16.00	16.00	
	347	<b>Hose Plug with Rocker Lug</b>	Cast	Chrome
		1 1/2" (38 mm).....	104.00	135.00
		2" (51 mm).....	109.00	144.00
2 1/2" (65 mm).....		148.00	136.00	
3" (75 mm).....			230.00	
3 1/2" (89 mm).....			393.00	
4" (102 mm).....			446.00	
4 1/2" (114 mm).....			535.00	
5" (127 mm).....			556.00	
6" (153 mm).....			623.00	
Add for Beaded Chain				
1 1/2" - 4" Only (38 - 102 mm).....		16.00	16.00	
350	<b>Mounting Plate</b>	Pyrolite®	Chrome	
	3/4" - 1 1/2" (19 - 38 mm).....		60.00	
	2 1/2" (65 mm).....		64.00	
	3" (75 mm).....		142.00	
	3 1/2" (89 mm).....		178.00	
	4" (102 mm).....		183.00	
	4 1/2" (114 mm).....		200.00	
	5" (127 mm).....		212.00	
6" (153 mm).....	241.00	227.00		
352	<b>2 1/2" Hose Jacket Mounting Peg</b> .....		178.00	
353	<b>3" Hose Jacket Mounting Peg</b> .....		206.00	
354	<b>Female Swivel To Male Adapter - Long Handle or Rocker Lug</b>			
	2 1/2" F x 2 1/2" M (65 x 65 mm).....		571.00	
	2 1/2" F x 3" M (65 x 75 mm).....		600.00	
	2 1/2" F x 3 1/2" M (65 x 89 mm).....		691.00	
	2 1/2" F x 4" M (65 x 102 mm).....		828.00	
	2 1/2" F x 4 1/2" M (65 x 114 mm).....		840.00	
	2 1/2" F x 5" M (65 x 127 mm).....		1,002.00	
	2 1/2" F x 6" M (65 x 153 mm).....		1,158.00	
	3" F x 2 1/2" M (75 x 65 mm).....		757.00	
	3" F x 3" M (75 x 75 mm).....		693.00	
	3" F x 3 1/2" M (75 x 89 mm).....		803.00	
	3" F x 4" M (75 x 102 mm).....		825.00	
	3" F x 4 1/2" M (75 x 114 mm).....		982.00	
	3 1/2" F x 2 1/2" M (89 x 65 mm).....		802.00	
	3 1/2" F x 3" M (89 x 75 mm).....		888.00	
3 1/2" F x 4 1/2" M (89 x 114 mm).....		1,132.00		
4" F x 2 1/2" M (102 x 65 mm).....		1,004.00		
4" F x 3" M (102 x 75 mm).....		1,232.00		
4" F x 4 1/2" M (102 x 114 mm).....		1,191.00		
4" F x 5" M (102 x 127 mm).....		1,403.00		
4" F x 6" M (102 x 153 mm).....		1,577.00		
4 1/2" F x 2 1/2" M (114 x 65 mm).....		1,014.00		
4 1/2" F x 4" M (114 x 102 mm).....		1,254.00		
4 1/2" F x 4 1/2" M (114 x 114 mm).....		1,311.00		
4 1/2" F x 5" M (114 x 127 mm).....		1,623.00		
4 1/2" F x 6" M (114 x 153 mm).....		1,802.00		
5" F x 4" M (127 x 102 mm).....		1,421.00		
5" F x 4 1/2" M (127 x 114 mm).....		1,623.00		

Style	Description	US\$ List Price	
354	<b>Female Swivel To Male Adapter (cont.)</b>		
	5" F x 6" M (127 x 153 mm).....	1,915.00	
	6" F x 2 1/2" M (153 x 65 mm).....	1,241.00	
	6" F x 4" M (153 x 102 mm).....	1,660.00	
	6" F x 4 1/2" M (153 x 114 mm).....	1,838.00	
	6" F x 5" M (153 x 127 mm).....	1,941.00	
356	<b>Rigid Female to Male Adapter</b>		
		<b>Cast</b>	<b>Chrome</b>
	2 1/2" F x 4" M (65 x 102 mm).....		449.00
	3" F x 4" M (75 x 102 mm).....	657.00	766.00
	3 1/2" F x 4" M (89 x 102 mm).....		719.00
	4" F x 2 1/2" M (102 x 65 mm).....	523.00	470.00
	4" F x 3" M (102 x 75 mm).....	553.00	657.00
	4" F x 3 1/2" M (102 x 89 mm).....		697.00
	4" F x 4" M (102 x 102 mm) Strainer optional.....	531.00	677.00
	4" F x 4 1/2" M (102 x 114 mm).....	587.00	795.00
	4" F x 5" M (102 x 127 mm).....		1,016.00
	4" F x 6" M (102 x 153 mm).....		1,496.00
	4 1/2" F x 2 1/2" M (114 x 65 mm).....	492.00	485.00
	4 1/2" F x 3" M (114 x 75 mm).....		1,170.00
	4 1/2" F x 4" M (114 x 102 mm).....	587.00	696.00
	4 1/2" F x 4 1/2" M (114 x 114 mm).....		822.00
	4 1/2" F x 5" M (114 x 127 mm).....		1,033.00
	4 1/2" F x 6" M (114 x 153 mm).....	1,076.00	1,076.00
	5" F x 2 1/2" M (127 x 65 mm).....		786.00
	5" F x 3" M (127 x 75 mm).....		831.00
	5" F x 4" M (127 x 102 mm).....		563.00
	5" F x 4 1/2" M (127 x 114 mm) Strainer optional.....		566.00
	5" F x 5" M (127 x 127 mm).....		1,191.00
5" F x 6" M (127 x 153 mm).....	1,229.00	1,583.00	
6" F x 3" M (153 x 75 mm).....		1,037.00	
6" F x 4" M (153 x 102 mm).....		700.00	
6" F x 4 1/2" M (153 x 114 mm) Strainer optional.....		725.00	
6" F x 5" M (153 x 127 mm) Strainer optional.....		775.00	
6" F x 6" M (153 x 153 mm).....	1,190.00	1,536.00	
357	<b>Double Female Swivel Adapter - Long Handle or Rocker Lug</b>		
		<b>Pyrolite®</b>	<b>Chrome</b>
	3 1/2" F x 3 1/2" F (89 x 89 mm).....		1,129.00
	4" F x 2 1/2" F (102 x 65 mm).....		755.00
	4" F x 3 1/2" F (102 x 89 mm).....		1,093.00
	4" F x 4" F (102 x 102 mm).....	1,143.00	929.00
	4 1/2" F x 2 1/2" F (114 x 65 mm).....	914.00	801.00
	4 1/2" F x 3" F (114 x 75 mm).....		1,181.00
	4 1/2" F x 4" F (114 x 102 mm).....		998.00
	4 1/2" F x 4 1/2" F (114 x 114 mm).....	1,533.00	1,005.00
	5" F x 2 1/2" F (127 x 65 mm).....	1,202.00	801.00
	5" F x 4" F (127 x 102 mm).....	1,624.00	1,025.00
	5" F x 4 1/2" F (127 x 114 mm).....	1,540.00	1,083.00
	5" F x 5" F (127 x 127 mm).....		1,157.00
	6" F x 2 1/2" F (153 x 65 mm).....	1,274.00	892.00
	6" F x 4" F (153 x 102 mm).....		1,165.00
6" F x 4 1/2" F (153 x 114 mm).....	1,523.00	1,171.00	
6" F x 5" F (153 x 127 mm).....	1,670.00	1,527.00	
6" F x 6" F (153 x 153 mm).....		2,340.00	
361	<b>Double Male Hex Nipple</b>		
		<b>Cast</b>	<b>Chrome</b>
	3/4" NPT x 3/4" GHT or NPSH (19 x 19 mm).....	98.00	
	1" NPT x 3/4" GHT (2.5 x 19 mm).....	106.00	
	1" NPT x 1" NH or NPSH (2.5 x 25 mm).....	98.00	106.00
	1 1/2" NPT x 1" NH (38 x 25 mm).....	106.00	
	1 1/2" NPT x 1 1/2" NH or NPSH (38 x 38 mm).....	111.00	114.00
	2" NPT x 1 1/2" NH (5.1 x 38 mm).....	153.00	206.00
	2" NPT x 2" NH (5.1 x 51 mm).....	163.00	174.00

Style	Description	US\$ List Price	
361	<b>Double Male Hex Nipple (cont.)</b>		
	2 1/2" NH, NPT x 2" NH, NPT or NPSH (65 x 51 mm).....	180.00	201.00
	2 1/2" NPT x 2 1/2" NH or NPSH (65 x 65 mm).....	180.00	201.00
362	<b>Female to Male Hex Nipple</b>		
		<b>Cast</b>	<b>Chrome</b>
	3/4" NPT F x 3/4" NH or NPSH M (19 x 19 mm).....	98.00	109.00
	3/4" GHT F x 1" NH M (19 x 25 mm).....	98.00	
	1" F x 3/4" GHT M (25 x 19 mm).....	98.00	138.00
	1" F x 1" M (25 x 25 mm).....	98.00	109.00
	1 1/2" F x 3/4" GHT M (38 x 19 mm).....	111.00	
	1 1/2" F x 1 1/2" M (38 x 38 mm).....	111.00	106.00
	2" F x 1 1/2" M (51 x 38 mm).....	142.00	194.00
	2" F x 2 1/2" M (51 x 65 mm).....	206.00	234.00
	2 1/2" F x 2 1/2" M (65 x 65 mm).....	180.00	201.00
	3" F x 2 1/2" M (75 x 65 mm).....	331.00	
373	<b>E-Z Lok Nozzle Holder</b>		
	1 1/2" (38 mm).....		159.00
	2 1/2" (65 mm).....		166.00
391	<b>Axial Playpipe with Plain Tip</b> ..... 1,658.00		
392	<b>Axial Playpipe with Threaded Tip</b> ..... 1,752.00		
393	<b>Axial Playpipe with Stacked Tips</b> ..... 2,041.00		
416	<b>Threaded Tip</b>		
		<b>Pyrolite®</b>	<b>Cast Chrome</b>
	1 1/2" F x 1 1/2" M (38 x 38 mm).....	281.00	245.00 281.00
417	<b>Plain Tip</b>		
	1 1/2" F (38 mm).....		150.00 187.00
420	<b>Triple Stacked Tips</b> ..... 570.00		
422	<b>Rigid Direct Connect Base</b>		
		<b>Cast</b>	<b>Chrome</b>
	2 1/2" F x 1 1/2" M (65 x 38 mm).....	303.00	349.00
426	<b>Playpipe with Ladder Hook</b> ..... 817.00		
438	<b>Plain Tip</b>		
		<b>Cast</b>	<b>Chrome</b>
	1 1/2" F (38 mm).....	138.00	157.00
439	<b>Dual Stacked Tips</b>		
	1 1/2" F with 15/16" and 1/2" Discharges (38 mm F with 24 and 13 mm Discharge).....		256.00
	1 1/2" F with 1 1/8" and 1/2" Discharges (38 mm F with 29 and 13 mm Discharge).....		256.00
441	<b>3 Wrench Holder</b> ..... 128.00		
442	<b>3 Wrench Holder</b>		
	with Wrenches (One (1) Style 15 and Two (2) Style 46).....		310.00
443	<b>3 Wrench Holder</b>		
	with Wrenches (One (1) Style 15 and Two (2) Style 10).....		298.00
446	<b>2 Wrench Holder</b> ..... 111.00		
447	<b>2 Wrench Holder</b>		
	with Wrenches (Two (2) Style 46).....		201.00
448	<b>2 Wrench Holder</b>		
	with Wrenches (Two (2) Style 10).....		189.00
449	<b>2 Wrench Holder</b>		
	with Wrenches (One (1) each Style 10 and 46)		195.00

**List Price Guide**  
 Effective: January 5, 2015  
 Akron Brass Company | PH: 800.228.1161 (330.264.5678) | FAX 800.531.7335 (330.264.2944) | www.akronbrass.com

Prices are for U.S. domestic resale and do not include International Tariffs, Taxes and Shipping  
 ♦ : denotes a \$68.00 per inlet upcharge if fitted with British Instantaneous (BIM or BIF), Japanese Instantaneous (JIM or JIF), or Storz connections



Style	Description	US\$ List Price		
485	<b>Brass Mini Stream Shaper</b>			
	1 1/2" (38 mm) .....			328.00
	2 1/2" (65 mm) .....			374.00
487	<b>GP Deluge Tip</b> .....			183.00
488	<b>Discharge Pipe</b>	<b>Aluminum</b>	<b>Cast</b>	<b>Chrome</b>
	2 1/2" F x 2 1/2" M (65 x 65 mm) .....	615.00	677.00	798.00
	3 1/2" F NPSH x 2 1/2" M (89x65 mm) .....	719.00	755.00	883.00
	3 1/2" F NPSH x 3" M NPSH (89x75 mm) .....	931.00	1,070.00	1,586.00
489	<b>Plain Deluge Tip</b>	<b>Aluminum</b>	<b>Cast</b>	<b>Chrome</b>
	2 1/2" F (65 mm) .....	372.00	403.00	450.00
	3" F (75 mm) .....	435.00	444.00	514.00
497	<b>Ladder Pipe Mounting Fixture</b> .....			336.00
499	<b>Triple Stacked Deluge Tips</b> .....			747.00
535	<b>2 1/2" Cellar Nozzle</b> .....			824.00
536	<b>1 1/2" Cellar Nozzle</b> .....			629.00
538	<b>Cellar Nozzle Applicator</b> .....			2,162.00
545	<b>1 1/2" Attic Nozzle</b> .....			620.00
583	<b>Hose Hoist</b> .....			466.00
588	<b>Hose Clamp with Mounting Bracket</b> .....			809.00
589	<b>Hose Clamp Mounting Bracket</b> .....			75.00
599	<b>Valve Manifold</b> .....			Price on Application
627	<b>4-Way Hydrant Valve</b> .....			4,119.00
630	<b>30° Angle Elbow</b>	<b>Cast</b>	<b>Chrome</b>	
	2 1/2" F x 2 1/2" M (65 x 65 mm) .....	477.00	419.00	
	3" F x 2 1/2" M (75 x 65 mm) .....		488.00	
	3" F x 3" M (75 x 75 mm) .....		521.00	
	4" F x 4" M (102 x 102 mm) (45° Angle) Chrome ends with red paint .....		1,212.00	
631	<b>60° Angle Elbow</b> .....			331.00
632	<b>90° Suction Elbow</b>	<b>Cast</b>	<b>Chrome</b>	
	2 1/2" F x 2 1/2" M (65 x 65 mm) Available with chrome ends with red paint .....	546.00	674.00	
	4" F x 4" M (102 x 102 mm) Chrome ends with red paint .....		1,589.00	
	5" F x 5" M (127 x 127 mm) .....	1,889.00	2,000.00	
633	<b>30° Discharge Elbow</b>			
	2 1/2" NPT F x 2 1/2" NH M (65 x 65 mm) .....			303.00
635	<b>Continuous Swiveling Elbow - Cast</b>			
	1 1/2" F NPT x 1 1/2" M NH or NPSH (2 7/16" Long) (38 x 38 mm) .....			197.00
	1 1/2" F NPT x 1 1/2" M NH or NPSH (4 5/8" Long) (38 x 38 mm) .....			197.00
	2" F NPT x 1 1/2" M NH or NPSH (2 7/16" Long) (51 x 38 mm) .....			207.00
	2" F NPT x 1 1/2" M NH or NPSH (4 5/8" Long) (51 x 38 mm) .....			207.00
	2 1/2" F NPT x 2 1/2" M NH (5" Long) (65 x 65 mm) .....			512.00
637	<b>4-Way Hydrant Valve Bracket</b> .....			532.00

Style	Description	US\$ List Price	
650	<b>Swiveling Elbow</b>		
	4" (102 mm) .....		1,302.00
	5" (127 mm) .....		1,430.00
	6" (153 mm) .....		1,563.00
655	<b>90° Front Suction Elbow - Cast</b>		
	4" NPT F x 4" NH M (102 x 102 mm) .....		1,401.00
	4" NPT F x 4 1/2" NH M (102 x 114 mm) .....		1,471.00
	5" NPT F x 5" NH M (127 x 127 mm) Chrome ends with red paint .....		1,699.00
	5" NPT F x 6" NH M (127 x 153 mm) Chrome ends with red paint .....		1,906.00
721	<b>Hose Rack Nozzle</b>	<b>Cast</b>	<b>Chrome</b>
	1" (25 mm) .....	◇ 363.00	517.00
	1 1/2" (38 mm) .....	◇ 433.00	644.00
753	<b>High Pressure Trigger Shutoff</b> .....		838.00
755	<b>Quick-Attack™ Foam Tube</b> .....		273.00
765	<b>Quick-Attack™ Foam Tube</b> .....		394.00
766	<b>Quick-Attack™ Foam Tube</b> .....		385.00
768	<b>Quick-Attack™ Foam Tube</b> .....		388.00
770	<b>Quick-Attack™ Foam Tube</b> .....		689.00
772	<b>2 1/2" Hose Jacket</b> .....		1,096.00
	Rubber Liner Replacement (P/N 7-29-011) .....		★ 53.25
773	<b>3" Hose Jacket</b> .....		1,303.00
	Rubber Liner Replacement (P/N 7-29-016) .....		★ 84.73
775	<b>Quick-Attack™ Foam Tube</b> .....		395.00
776	<b>Quick-Attack™ Foam Tube</b> .....		419.00
777	<b>Quick-Attack™ Foam Tube</b> .....		384.00
785	<b>Quick-Attack™ Foam Tube</b> .....		418.00
866	<b>Mid-X Medium™ Expansion Foam Tube</b> .....		686.00
868	<b>Mid-X Medium™ Expansion Foam Tube</b> .....		689.00
877	<b>Mid-X Medium™ Expansion Foam Tube</b> .....		686.00
911	<b>Ozzie™ Oscillating Monitor</b> .....	◇	4,329.00
922	<b>OzzieMaster™ Oscillating Monitor</b>		
	Liftoff Only .....		4,279.00
	Single Inlet Ground Base Only .....		2,252.00
	Dual Inlet Ground Base Only 2 1/2" (65 mm) .....	◇	2,022.00
	Dual Inlet Ground Base Only 3" (75 mm) .....	◇	2,123.00
	Direct Mount Flange Only .....		415.00
	Adapter for Style 3410 through 3413 Single Inlet Ground Base .....		406.00
1030	<b>1" Forestry Nozzle</b> .....		171.00
1034	<b>1 1/2" Coast Guard Fog Head</b> .....		161.00
1048	<b>2 1/2" Coast Guard Fog Head</b> .....		185.00
1078	<b>Quickfit Sprinkler Shutoff</b> .....		62.00



Style	Description	US\$ List Price
1088	<b>Piercing Applicator</b> 1 1/2" F x 3 Feet (38 mm x .91 m)..... ◆1,171.00 1 1/2" F x 6 Feet (38 mm x 1.83 m)..... ◆1,249.00 3 Foot (.91 m) Extension (P/N PA-3D)..... 68.00	
1116	<b>Shutoff and Plain Tip</b> <b>Cast Chrome</b> 1 1/2" F x 1 1/2" M (38 x 38 mm)..... 617.00 ..... 702.00	
1125	<b>Shutoff</b> <b>Cast Chrome</b> 1 1/2" F x 1 1/2" M (38 x 38 mm)..... 479.00 ..... 545.00	
1126	<b>Shutoff and Plain Tip</b> <b>Cast Chrome</b> 1 1/2" F x 1 1/2" M (38 x 38 mm)..... 629.00 ..... 732.00	
1127	<b>Shutoff and Threaded Tip</b> <b>Cast Chrome</b> 1 1/2" F x 1 1/2" M (38 x 38 mm)..... 724.00 ..... 826.00	
1131	<b>Playpipe, Shutoff and Plain Tip</b> ..... 1,549.00	
1132	<b>Playpipe, Shutoff and Threaded Tip</b> ..... 1,643.00	
1135	<b>Playpipe, Shutoff and Stacked Tips</b> ..... 1,932.00	
1230	<b>1" Self-Educting Gel Nozzle</b> ..... 1,164.00 1" Self-Educting Gel Nozzle with 5' Pickup Hose..... 1,337.00	
1256	<b>3-Way Clappered Siamese</b> (3) 2 1/2" F x 2 1/2" M or F (65 x 65 mm)..... 1,936.00 (3) 2 1/2" F x 3" M or F (65 x 75 mm)..... 2,171.00 (3) 2 1/2" F x 3 1/2" M or F (65 x 89 mm) ..... 2,315.00 (3) 2 1/2" F x 4" M or F (65 x 102 mm)..... 2,458.00 (3) 2 1/2" F x 4 1/2" M or F (65 x 114 mm)..... 2,653.00 (3) 2 1/2" F x 5" M or F (65 x 127 mm)..... 2,935.00 (3) 2 1/2" F x 6" M or F (65 x 153 mm)..... 2,947.00	
1260	<b>Plain Wye</b> 2 1/2" F x (2) 2 1/2" M (65 x 65 mm)..... 567.00 3" F x (2) 2 1/2" M (75 x 65 mm) ..... 832.00 3 1/2" F x (2) 2 1/2" M (89 x 65 mm) ..... 904.00 4" F x (2) 2 1/2" M (102 x 65 mm) ..... 920.00 4 1/2" F x (2) 2 1/2" M (114 x 65 mm)..... 1,020.00 5" F x (2) 2 1/2" M (127 x 65 mm)..... 1,093.00 6" F x (2) 2 1/2" M (153 x 65 mm)..... 1,273.00	
1262	<b>Clapper Valve Siamese</b> 2 1/2" M x (2) 2 1/2" F (65 x 65 mm)..... 1,289.00 3" M x (2) 2 1/2" F (75 x 65 mm)..... 1,413.00 3" M x (2) 3" F (75 x 75 mm)..... 1,481.00	
1267	<b>Clapper Valve Siamese</b> 2 1/2" F x (2) 2 1/2" F (65 x 65 mm)..... 1,631.00 3" F x (2) 2 1/2" F (75 x 65 mm)..... 1,652.00 4" M or F x (2) 2 1/2" F (102 x 65 mm)..... 1,710.00 4" Storz x (2) 2 1/2" F (102 x 65 mm)..... 1,710.00 4 1/2" M or F x (2) 2 1/2" F (114 x 65 mm)..... 1,845.00 5" M or F x (2) 2 1/2" F (127 x 65 mm) ..... 1,949.00 5" Storz x (2) 2 1/2" F (127 x 65 mm)..... 1,949.00 6" M or F x (2) 2 1/2" F (153 x 65 mm)..... 2,134.00	
1300	<b>1 1/2" Industrial Fog Nozzle</b> ..... ◆ 364.00	
1390	<b>Axial Playpipe</b> ..... 1,471.00	
1410	<b>Plain Tip</b> ..... 146.00	

Style	Description	US\$ List Price
1417	<b>Plain Tip</b> ..... 132.00	
1420	<b>Triple Stacked Tips</b> ..... 460.00	
1422	<b>Rigid Direct Connect Base</b> ..... 327.00	
1430	<b>Threaded Saber™ Tip</b> ..... 139.00	
1440	<b>Shutoff and Dual Stacked Tips</b> ..... ◆765.00	
1441	<b>Shutoff with Pistol Grip and Dual Stacked Tips</b> 5/8" and 1/2" Tips (24 and 13 mm)..... ◆809.00	
1442	<b>Shutoff and Dual Stacked 1 1/8" and 1/2" Tips</b> ..... ◆889.00 1442HFX with HydroFX™ Flow Indicator..... ◆1,285.00	
1443	<b>Shutoff with Pistol Grip and Dual Stacked Tips</b> 1 1/8" and 1/2" Tips (29 and 13 mm)..... ◆930.00 1443HFX with HydroFX™ Flow Indicator..... ◆1,326.00	
1445	<b>Shutoff with Pistol Grip and Straight Tip</b> ..... ◆702.00	
1446	<b>Shutoff with Pistol Grip and Plain Tip</b> ..... ◆823.00 1446HFX with HydroFX™ Flow Indicator..... ◆1,219.00	
1477	<b>Push/Pull Remote Control</b> with Style 1490 Recessed T-Handle..... 136.00 Ball Joint Assembly for Style 1477 & 1478 (P/N 1477-0001)..... 24.00	
1478	<b>Push/Pull Remote Control</b> with Style 1489 Plain T-Handle..... 154.00 Ball Joint Assembly for Style 1477 & 1478 (P/N 1477-0001)..... 24.00	
1480	<b>1 1/2" Wye</b> <b>Cast Chrome</b> 1 1/2" F x (2) 1 1/2" M (38 x 38 mm)..... 1,242.00 ..... 1,322.00	
1482	<b>Hydrant Wye</b> <b>Cast Chrome</b> 2 1/2" F x (2) 2 1/2" M (65 x 65 mm)..... 1,955.00 ..... 2,217.00 3" F x (2) 2 1/2" M (75 x 65 mm)..... 2,099.00 ..... 2,372.00 3 1/2" F x (2) 2 1/2" M (89 x 65 mm)..... 2,099.00 ..... 4" F x (2) 2 1/2" M (102 x 65 mm)..... 2,166.00 ..... 2,598.00 4 1/2" F x (2) 2 1/2" M (114 x 65 mm) ..... 2,354.00 ..... 2,661.00 5" F x (2) 2 1/2" M (127 x 65 mm) ..... 2,541.00 ..... 2,883.00 6" F x (2) 2 1/2" M (153 x 65 mm) ..... 2,680.00 ..... 3,034.00	
1483	<b>Suction Siamese</b> <b>Cast Chrome</b> (2) 2 1/2" F x 2 1/2" M or F (65 x 65 mm)..... 1,905.00 ..... 2,236.00 (2) 2 1/2" F x 3" F or M (65 x 75 mm)..... 2,045.00 ..... 2,539.00 (2) 2 1/2" F x 4" M or F (65 x 102 mm) ..... 2,234.00 ..... 2,634.00 (2) 2 1/2" F x 4 1/2" M or F (65 x 114 mm) ..... 2,287.00 ..... 2,697.00 (2) 2 1/2" F x 5" M or F (65 x 127 mm) ..... 2,473.00 ..... 2,911.00 (2) 2 1/2" F x 6" M or F (65 x 153 mm) ..... 2,608.00 ..... 3,070.00	
1489	<b>Plain T-Handle</b> ..... 61.00	
1490	<b>T-Handle with Recess</b> ..... 43.00	
1495	<b>Ladder Pipe</b> with Pipe, 3 Deluge Tips, and 2 Mounting Brackets..... 7,654.00 less Pipe and Deluge Tips ..... 5,594.00 Mounting Fixture..... 344.00	
1496	<b>Classic Ladder Pipe (750 gpm max)</b> less Pipe and Deluge Tips..... 5,040.00	

Style	Description	US\$ List Price
1499	<b>Plain Tip</b> .....	149.00
1512	<b>1" SaberJet™ Nozzle with Pistol Grip</b> 3/8", 1/2" or 5/8" Tip Option (9.5, 13 or 16.4 mm).....	1,271.00
	Tip Replacement Kit.....	94.00
1513	<b>1" SaberJet™ Nozzle</b> 3/8", 1/2" or 5/8" Tip Option (9.5, 13 or 16.4 mm).....	1,271.00
	Tip Replacement Kit.....	94.00
1515	<b>1 1/2" SaberJet™ Nozzle</b> 3/8", 1/2" or 5/8" Tip Option (9.5, 13 or 16.4 mm).....	1,271.00
	Tip Replacement Kit.....	94.00
	ZT Conversion Kit.....	275.00
1515ZT	<b>1 1/2" SaberJet™ Zero Torque™ Nozzle</b> 3/8", 1/2" or 5/8" Tip Option (9.5, 13 or 16.4 mm).....	1,441.00
	Tip Replacement Kit.....	94.00
1520	<b>1 1/2" SaberJet™ Nozzle with Pistol Grip</b> 3/8", 1/2" or 5/8" Tip Option (9.5, 13 or 16.4 mm).....	1,296.00
	Tip Replacement Kit.....	94.00
1522	<b>Mid-Range SaberJet™ Nozzle</b> 3/4", 7/8", 15/16" or 1" Tip Option (19, 22, 24 or 25 mm).....	1,284.00
	Tip Replacement Kit.....	94.00
	ZT Conversion Kit.....	275.00
1522ZT	<b>Mid-Range SaberJet™ Zero Torque™ Nozzle</b> 3/4", 7/8", 15/16" or 1" Tip Option (19, 22, 24 or 25 mm).....	1,454.00
	Tip Replacement Kit.....	94.00
1523	<b>Mid-Range SaberJet™ Nozzle with Pistol Grip</b> 3/4", 7/8", 15/16" or 1" Tip Option (19, 22, 24 or 25 mm).....	1,284.00
	Tip Replacement Kit.....	94.00
1525	<b>2 1/2" SaberJet™ Nozzle</b> 3/4", 7/8", 15/16" or 1" Tip Option (19, 22, 24 or 25 mm).....	1,399.00
	Tip Replacement Kit.....	94.00
	ZT Conversion Kit.....	275.00
1525ZT	<b>2 1/2" SaberJet™ Zero Torque™ Nozzle</b> 3/4", 7/8", 15/16" or 1" Tip Option (19, 22, 24 or 25 mm).....	1,569.00
	Tip Replacement Kit.....	94.00
1526	<b>2 1/2" SaberJet™ Nozzle with Pistol Grip</b> 3/4", 7/8", 15/16" or 1" Tip Option (19, 22, 24 or 25mm).....	1,399.00
	Tip Replacement Kit.....	94.00
1527	<b>2 1/2" SaberJet™ Nozzle</b> 1 1/8" Tip Option (29 mm).....	1,410.00
	Tip Replacement Kit.....	94.00
	ZT Conversion Kit.....	275.00
1527ZT	<b>2 1/2" SaberJet™ Zero Torque™ Nozzle</b> 1 1/8" Tip Option (29 mm).....	1,580.00
	Tip Replacement Kit.....	94.00
1528	<b>2 1/2" SaberJet™ Nozzle with Pistol Grip</b> 1 1/8" Tip Option (29 mm).....	1,410.00
	Tip Replacement Kit.....	94.00
1532	<b>Mid-Range Single Shutoff SaberJet™ Nozzle</b> 3/4", 7/8", 15/16" or 1" Tip Option (19, 22, 24 or 25 mm).....	1,255.00
	Tip Replacement Kit.....	94.00
	ZT Conversion Kit.....	275.00

Style	Description	US\$ List Price
1532ZT	<b>Mid-Range Single Shutoff SaberJet™ Zero Torque™ Nozzle</b> 3/4", 7/8", 15/16" or 1" Tip Option (19, 22, 24 or 25 mm).....	1,425.00
	Tip Replacement Kit.....	94.00
1533	<b>Mid-Range Single Shutoff SaberJet™ Nozzle with Pistol Grip</b> 3/4", 7/8", 15/16" or 1" Tip Option (19, 22, 24 or 25 mm).....	1,255.00
	Tip Replacement Kit.....	94.00
1535	<b>2 1/2" Single Shutoff SaberJet™ Nozzle</b> 3/4", 7/8", 15/16" or 1" Tip Option (19, 22, 24 or 25 mm).....	1,382.00
	Tip Replacement Kit.....	94.00
	ZT Conversion Kit.....	275.00
1535ZT	<b>2 1/2" Single Shutoff SaberJet™ Zero Torque™ Nozzle</b> 3/4", 7/8", 15/16" or 1" Tip Option (19, 22, 24 or 25 mm).....	1,552.00
	Tip Replacement Kit.....	94.00
1536	<b>2 1/2" Single Shutoff SaberJet™ Nozzle with Pistol Grip</b> 3/4", 7/8", 15/16" or 1" Tip Option (19, 22, 24 or 25 mm).....	1,382.00
	Tip Replacement Kit.....	94.00
1545	<b>SaberMaster™ 500 Nozzle</b> .....	1,156.00
1573	<b>Water Thief</b> .....	1,962.00
1577	<b>SaberMaster™ 1250 Electric Nozzle</b> .....	4,031.00
	Some older monitors will require a PC board upgrade at an additional cost. Contact Customer Service for details.	
1581	<b>Leader Line Wye</b> .....	922.00
	Retrofit Kit - To upgrade 1 1/2" (38 mm) Gated Wye Handles with older style Tork-Lok® mechanism to stainless steel (P/N 1581-0061).....	261.99
1582	<b>Hydrant Wye</b> 2 1/2" F x (2) 2 1/2" M (65 x 65 mm).....	1,911.00
	3" F x (2) 2 1/2" M (75 x 65 mm).....	2,047.00
	3 1/2" F x (2) 2 1/2" M (89 x 65 mm).....	2,184.00
	4" F x (2) 2 1/2" M (102 x 65 mm).....	2,237.00
	4" Storz x (2) 2 1/2" M (102 x 65 mm).....	2,237.00
	4 1/2" F x (2) 2 1/2" M (114 x 65 mm).....	2,300.00
	5" F x (2) 2 1/2" M (127 x 65 mm).....	2,478.00
	5" Storz x (2) 2 1/2" M (127 x 65 mm).....	2,478.00
	6" F x (2) 2 1/2" M (153 x 65 mm).....	2,588.00
	Retrofit Kit - To upgrade 2 1/2" (65 mm) Gated Wye Handles with older style Tork-Lok® mechanism to stainless steel (P/N 1582-0053).....	299.05
1583	<b>Suction Siamese</b> (2) 2 1/2" F x 2 1/2" M or F (65 x 65 mm).....	1,935.00
	(2) 2 1/2" F x 3" M or F (65 x 75 mm).....	2,105.00
	(2) 2 1/2" F x 4" M or F (65 x 102 mm).....	2,297.00
	(2) 2 1/2" F x 4" Storz (65 x 102 mm).....	2,297.00
	(2) 2 1/2" F x 4 1/2" M or F (65 x 114 mm).....	2,365.00
	(2) 2 1/2" F x 5" M or F (65 x 127 mm).....	2,549.00
	(2) 2 1/2" F x 5" Storz (65 x 127 mm).....	2,549.00
	(2) 2 1/2" F x 6" M or F (65 x 153 mm).....	2,661.00
	Retrofit Kit - To upgrade 2 1/2" (65 mm) Gated Wye Handles with older style Tork-Lok® mechanism to stainless steel (P/N 1582-0053).....	299.05
1615	<b>1 1/2" Avenger™ Selectable Gallonage Nozzle</b> .....	798.00
1615HFX	with HydroFX™ Flow Indicator.....	1,194.00

Style	Description	US\$ List Price
1616	<b>1 1/2" Avenger™ Selectable Gallonage Nozzle with Pistol Grip</b> .....	◇798.00
1616HFX	with HydroFX™ Flow Indicator.....	◇1,194.00
1700	<b>Aussie™ Bush Nozzle</b> .....	◇760.00
1701	<b>1" Turbojet® Nozzle</b> .....	◇989.00
1702	<b>1" Turbojet® Nozzle with Pistol Grip</b> .....	◇1,072.00
1703	<b>1" Turbojet® Tip with 1 1/4" Inlet</b> .....	696.00
1704	<b>1" Turbojet® Nozzle with Pistol Grip</b> .....	◇1,117.00
1711	<b>1" Turbojet® Tip with 1 1/4" Inlet</b> .....	716.00
1714	<b>1 1/2" Turbojet® Tip</b> .....	679.00
1715	<b>1 1/2" Turbojet® Nozzle</b> .....	◇1,066.00
	ZT Conversion Kit.....	◇275.00
1715E	<b>1 1/2" Electrical Turbojet® Nozzle</b> .....	◇1,066.00
1715ZT	<b>1 1/2" Turbojet® Zero Torque™ Nozzle</b> .....	◇1,236.00
1716	<b>1 1/2" Turbojet® Breakapart Nozzle</b> .....	◇1,195.00
1717	<b>1 1/2" Turbojet® Tip with Twist Shutoff</b> .....	760.00
1718	<b>1 1/2" Turbojet® Breakapart Nozzle with Pistol Grip</b> .....	◇1,276.00
1719	<b>Pistol Grip Adapter 1 1/2" x 1 1/2"</b> .....	◇280.00
1720	<b>1 1/2" Turbojet® Nozzle with Pistol Grip</b> .....	◇1,136.00
1720E	<b>1 1/2" Electrical Turbojet® Nozzle with Pistol Grip</b> .....	◇1,136.00
1722	<b>Mid-Range Turbojet® Nozzle</b> .....	◇1,293.00
1722HFX	with HydroFX™ Flow Indicator.....	◇1,698.00
	ZT Conversion Kit.....	◇275.00
1722ZT	<b>Mid-Range Turbojet® Zero Torque™ Nozzle</b> .....	◇1,472.00
1723	<b>Mid-Range Turbojet® Nozzle with Pistol Grip</b> .....	◇1,293.00
1723HFX	with HydroFX™ Flow Indicator.....	◇1,689.00
1724	<b>Mid-Range Turbojet® Tip with Twist Shutoff</b> .....	851.00
1725	<b>2 1/2" High-Range Turbojet® Nozzle</b> .....	◇1,392.00
1725HFX	with HydroFX™ Flow Indicator.....	◇1,788.00
	ZT Conversion Kit.....	◇275.00
1725ZT	<b>2 1/2" High-Range Turbojet® Zero Torque™ Nozzle</b> .....	◇1,562.00
1726	<b>2 1/2" High-Range Turbojet® Breakapart Nozzle</b> .....	◇1,486.00
1726HFX	with HydroFX™ Flow Indicator.....	◇1,882.00
1727	<b>1 1/2" High-Range Turbojet® Tip with Twist Shutoff with 1 1/2" Inlet</b> .....	853.00
1728	<b>1 1/2" High-Range Turbojet® Breakapart Nozzle with 1 1/2" Inlet</b> .....	◇1,355.00

Style	Description	US\$ List Price
1733	<b>2 1/2" High-Range Turbojet® Nozzle with Pistol Grip</b> .....	◇1,392.00
1733HFX	with HydroFX™ Flow Indicator.....	◇1,788.00
1734	<b>Mid-Range Turbojet® Breakapart Nozzle</b> .....	◇1,360.00
1735	<b>Mid-Range Turbojet® Breakapart Nozzle with Pistol Grip</b> .....	◇1,404.00
1736	<b>2 1/2" High-Range Turbojet® Breakapart Nozzle with Pistol Grip</b> .....	◇1,527.00
1736HFX	with HydroFX™ Flow Indicator.....	◇1,923.00
1737	<b>Mid-Range Turbojet® Tip</b> .....	851.00
1738	<b>1 1/2" High-Range Turbojet® Breakapart Nozzle 1 1/2" Inlet with Pistol Grip</b> .....	◇1,406.00
1741	<b>Industrial Turbojet® Nozzle with Pistol Grip</b> .....	◇1,243.00
1744	<b>1 1/2" High-Range Turbojet® Tip with 1 1/2" Inlet</b> .....	865.00
1745	<b>TurboMaster™ Master Stream Nozzle</b> .....	1,728.00
1747	<b>Excel 1000™ Master Stream Nozzle</b> .....	1,299.00
1755	<b>TurboMaster™ Master Stream Nozzle</b> .....	1,684.00
1757	<b>TurboMaster™ Master Stream Nozzle</b> .....	1,711.00
1762	<b>Wide-Range Turbojet® Nozzle</b> .....	◇1,162.00
1762HFX	with HydroFX™ Flow Indicator.....	◇1,558.00
	ZT Conversion Kit.....	◇275.00
1762ZT	<b>Wide-Range Turbojet® Zero Torque™ Nozzle</b> .....	◇1,332.00
1763	<b>Wide-Range Turbojet® Nozzle with Pistol Grip</b> .....	◇1,162.00
1763HFX	with HydroFX™ Flow Indicator.....	◇1,558.00
1764	<b>Wide-Range Turbojet® Breakapart Nozzle</b> .....	◇1,310.00
1765	<b>Wide-Range Turbojet® Breakapart Nozzle with Pistol Grip</b> .....	◇1,354.00
1766	<b>Wide-Range Turbojet® Tip</b> .....	801.00
1767	<b>Wide-Range Turbojet® Tip with Twist Shutoff</b> .....	801.00
1772	<b>1" Ultra-Wide Turbojet® Nozzle</b> .....	1,197.00
1828	<b>2 1/2" Hydrant Valve</b> .....	◇1,130.00
	Retrofit Kit - To upgrade 2 1/2" (65 mm) Hydrant Valves with older style Tork-Lok® mechanism to stainless steel (P/N 1582-0053).....	★299.05
2001	<b>Challenger™ Dual-Flow Foam Nozzle</b> .....	◇2,388.00
2015	<b>Coast Guard Applicator</b> .....	636.00
2032	<b>1 1/2" CG-15 Nozzle</b> .....	768.00
2033	<b>1 1/2" Fog Tip with Chain</b> .....	171.00
2046	<b>2 1/2" CG-25 Nozzle</b> .....	902.00
2047	<b>2 1/2" Fog Tip with Chain</b> .....	200.00

Style	Description	US\$ List Price	
2055	<b>Fog Applicator</b> 4' Long (1.22 m).....	584.00	
	6' Long (1.83 m).....	608.00	
	10' Long (3.05 m).....	688.00	
2069	<b>4AN Navy Nozzle 1 1/2"</b> .....	803.00	
2073	<b>1 1/2" Fog Tip with Chain</b> .....	185.00	
2074	<b>4AN Navy Nozzle 2 1/2"</b> .....	1,140.00	
2077	<b>2 1/2" Fog Tip with Chain</b> .....	244.00	
2079	<b>4AN Military Nozzle 2 1/2"</b> .....	846.00	
2083	<b>1 1/2" Fog Tip with Chain</b> .....	186.00	
2101	<b>1" Shutoff</b> .....	◇ 511.00	
2102	<b>1" Shutoff with Pistol Grip</b> .....	◇ 511.00	
2108	<b>1" x 1 1/2" Shutoff with Pistol Grip</b> .....	◇ 526.00	
2115	<b>1 1/2" Shutoff</b> .....	◇ 435.00	
2116	<b>1 1/2" Shutoff with Pistol Grip</b> .....	◇ 516.00	
2120	<b>In-Line Eductor</b> .....	Cast 1,357.00	Chrome 1,748.00
2125	<b>2 1/2" X 1 1/2" Shutoff</b> .....	◇ 633.00	
2125HFX	with HydroFX™ Flow Indicator.....	◇ 1,029.00	
	ZT Conversion Kit.....	◇ 275.00	
2125ZT	<b>2 1/2" X 1 1/2" Zero Torque™ Shutoff</b> .....	◇ 803.00	
2126	<b>2 1/2" x 1 1/2" Shutoff with Pistol Grip</b> .....	◇ 674.00	
2126HFX	with HydroFX™ Flow Indicator.....	◇ 1,070.00	
2127	<b>1 1/2" x 1 1/2" Shutoff with Pistol Grip</b> .....	◇ 553.00	
2129	<b>1 1/2" x 1 1/2" Shutoff</b> .....	◇ 509.00	
	ZT Conversion Kit.....	◇ 275.00	
2129ZT	<b>1 1/2" x 1 1/2" Zero Torque™ Shutoff</b> .....	◇ 679.00	
2130	<b>2 1/2" x 2 1/2" Shutoff</b> .....	◇ 894.00	
2151	<b>Black Widow® Manual Master Stream Nozzle- Brass 300 - 1250 GPM</b> .....	1,349.00	
2152	<b>Black Widow® Manual Master Stream Nozzle 300 - 1250 GPM</b> .....	1,230.00	
2155	<b>Black Widow® Hydraulic Master Stream Nozzle 300 - 1250 GPM</b> .....	1,593.00	
2156	<b>Black Widow® Hydraulic Master Stream Nozzle - Brass 300 - 1250 GPM</b> .....	1,771.00	
2157	<b>Excel™ Hydraulic Master Stream Nozzle 300 - 500 - 800 - 1000 GPM</b> .....	2,165.00	
2158	<b>Black Widow® Hydraulic Master Stream Nozzle 300 - 1500 GPM</b> .....	2,126.00	

Style	Description	US\$ List Price
2171	<b>Single Gallonage Master Stream Nozzle</b> .....	2,088.00
2188	<b>Renegade™ Fixed Flow Nozzle</b> .....	12,333.00
2189	<b>Renegade™ Adjustable Flow Nozzle</b> .....	12,333.00
2225	<b>2 1/2" Coast Guard Applicator</b> 6' long (1.8 m).....	635.00
	10' long (3 m).....	803.00
	12' long (3.7 m).....	803.00
2285	<b>Gate Valve</b> 2 1/2" (65 mm).....	◇ 771.00
	3" (75 mm).....	◇ 868.00
2286	<b>Gate Valve</b> 3", 3 1/2" and 4" Threaded (75, 89 and 100 mm).....	1,369.00
	4 1/2" and 5" Threaded (110 and 125 mm).....	1,481.00
	Additional Charge per Storz on each side.....	68.00
2302	<b>Advantage™ Eductor 250 GPM</b> .....	1,898.00
	with Foam Shutoff Valve.....	2,052.00
2305	<b>Advantage™ Eductor 500 GPM</b> .....	1,917.00
	with Foam Shutoff Valve.....	2,071.00
2307	<b>Advantage™ Eductor 700 GPM</b> .....	1,954.00
	with Foam Shutoff Valve.....	2,108.00
2310	<b>Advantage™ Eductor 1000 GPM</b> .....	1,918.00
	with Foam Shutoff Valve.....	2,071.00
2325	<b>95 GPM In-Line Eductor</b> .....	◇ 1,004.00
2328	<b>90 GPM In-Line Eductor with 1 1/2" Inlet and Shutoff Valve</b> .....	◇ 1,081.00
2390	<b>Axial Playpipe</b> .....	◇ 1,034.00
2393	<b>Axial Playpipe with Stacked Tips</b> .....	◇ 1,501.00
2400	<b>1 1/2" NH Thread Protector</b> .....	46.00
	1 1/2" Thread Protector with Custom Threads.....	59.00
2415	<b>1 1/2" Coast Guard Applicator</b> .....	378.00
2420	<b>Triple Stacked Tips</b> .....	476.00
2428	<b>1" Saber™ Shutoff</b> .....	◇ 578.00
2429	<b>1" Saber™ Shutoff with Pistol Grip</b> .....	◇ 627.00
2430	<b>1 1/2" Saber™ Shutoff</b> .....	◇ 537.00
2430HFX	with HydroFX™ Flow Indicator.....	◇ 933.00
2431	<b>1 1/2" Saber™ Shutoff with Pistol Grip</b> .....	◇ 580.00
2431HFX	with HydroFX™ Flow Indicator.....	◇ 976.00
2432	<b>2 1/2" Saber™ Shutoff</b> .....	◇ 684.00
2432HFX	with HydroFX™ Flow Indicator.....	◇ 1,080.00
2433	<b>2 1/2" Saber™ Shutoff with Pistol Grip</b> .....	◇ 720.00
2433HFX	with HydroFX™ Flow Indicator.....	◇ 1,116.00
2441	<b>3 Wrench Holder</b> .....	99.00

Prices are for U.S. domestic resale and do not include International Tariffs, Taxes and Shipping  
 ◇ : denotes a \$68.00 per inlet upcharge if fitted with British Instantaneous (BIM or BIF), Japanese Instantaneous (JIM or JIF), or Storz connections



Style	Description	US\$ List Price
2442	<b>3 Wrench Holder with Wrenches (One (1) Style 15, Two (2) Style 46)</b> .....	281.00
2443	<b>3 Wrench Holder with Wrenches (One (1) Style 15, Two (2) Style 10)</b> .....	269.00
2446	<b>2 Wrench Holder</b> .....	95.00
2447	<b>2 Wrench Holder with Wrenches (Two (2) Style 46)</b> .....	185.00
2448	<b>2 Wrench Holder with Wrenches (Two (2) Style 10)</b> .....	173.00
2489	<b>Master Stream Tip</b> .....	513.00
2498	<b>Triple Stacked Deluge Tips</b> .....	625.00
2499	<b>Quad Stacked Deluge Tips</b> .....	692.00
2580	<b>1 1/2" Wye</b> .....	◇529.00
2581	<b>Leader Line Wye</b> .....	◇516.00
2582	<b>3-Way Hydrant Wye</b>	
	(3) 2 1/2" M x 2 1/2" F (65 x 65 mm).....	3,009.00
	(3) 2 1/2" M x 3" F (65 x 75 mm).....	3,141.00
	(3) 2 1/2" M x 3 1/2" F (65 x 89 mm).....	3,287.00
	(3) 2 1/2" M x 4" F (65 x 102 mm).....	3,384.00
	(3) 2 1/2" M x 4 1/2" F (65 x 114 mm).....	3,445.00
	(3) 2 1/2" M x 5" F (65 x 127 mm).....	3,613.00
	(3) 2 1/2" M x 6" F (65 x 153 mm).....	3,752.00
2583	<b>3-Way Suction Siamese</b>	
	(3) 2 1/2" F x 2 1/2" F or M (65 x 65 mm).....	3,037.00
	(3) 2 1/2" F x 3" F or M (65 x 75 mm).....	3,200.00
	(3) 2 1/2" F x 3 1/2" F or M (65 x 89 mm).....	3,334.00
	(3) 2 1/2" F x 4" F or M (65 x 102 mm).....	3,451.00
	(3) 2 1/2" F x 4 1/2" F or M (65 x 114 mm).....	3,509.00
	(3) 2 1/2" F x 5" F or M (65 x 127 mm).....	3,688.00
	(3) 2 1/2" F x 6" F or M (65 x 153 mm).....	3,822.00
2681	<b>Leader Line Wye</b> .....	◇632.00
2700	<b>Bronco™ Deck Pipe</b> .....	2,685.00
2730	<b>2 1/2" High-Range Turbojet® Tip with Axial Playpipe</b> .....	◇1,918.00
2775	<b>Hydrant Mount</b> .....	◇1,472.00
2901	<b>90 GPM In-Line Eductor</b> .....	1,020.00
3015	<b>1 1/2" Brass Fog Nozzle</b> .....	◇775.00
3016	<b>1 1/2" Brass Fog Nozzle</b> .....	◇781.00
3019	<b>1 1/2" Brass Fog Nozzle with Pistol Grip</b> .....	◇798.00
3020	<b>1 1/2" Shipboard Vari-Nozzle with Pistol Grip</b> .....	◇812.00
3021	<b>1 1/2" Brass Fog Nozzle with Pistol Grip</b> .....	◇816.00
3022	<b>1 1/2" Shipboard Vari-Nozzle</b> .....	◇751.00
3023	<b>1 1/2" Shipboard Vari-Nozzle with Pistol Grip</b> .....	◇827.00

Style	Description	US\$ List Price
3025	<b>2 1/2" Brass Fog Nozzle</b> .....	◇1,146.00
3030	<b>Jet Ratio Controller with Pickup Assembly</b> .....	◇1,847.00
3060	<b>60 GPM Pyrolite® In-Line Eductor</b> .....	◇1,030.00
3061	<b>60 GPM Truck Foam System</b> 60 GPM Truck Kit - 1 Tank Includes: Eductor, Foam Panel, (1) 2" (51 mm) Valve with built in Check Valve, (1) Check Valve, (2) 1" (25 mm) Valves, (4) 1477 Remotes with Tags.....	4,857.00
	2 Tank Same as One Tank with (1) Extra 1" Valve, (1) Check Valve, (1) 1477 Remote and Tag.....	5,413.00
	60 GPM (230 LPM) Eductor Only.....	1,833.00
	60 GPM (230 LPM) Metering Panel Only.....	684.00
3062	<b>60 GPM Portable By-Pass Eductor</b> .....	◇2,099.00
	Eductor Conversion Kit for Styles 2600 and 2608.....	770.00
3070	<b>60 GPM Brass In-Line Eductor</b> .....	◇1,366.00
3071	<b>95 GPM Brass In-Line Eductor</b> .....	◇1,305.00
3072	<b>125 GPM Brass In-Line Eductor</b> .....	◇1,363.00
3095	<b>95 GPM Pyrolite® In-Line Eductor</b> .....	◇989.00
	Eductor with On-Board Foam Access.....	◇1,471.00
3096	<b>95 GPM Truck Foam System</b> 95 GPM (360 LPM) Truck Kit - 1 Tank Includes: Eductor, Foam Panel, (1) 2" (51 mm) Valve with built in Check Valve, (1) Check Valve, (2) 1" (25 mm) Valves, (4) 1477 Remotes with Tags.....	5,109.00
	2 Tank Same as One Tank with (1) Extra 1" (25 mm) Valve, (1) Check Valve, (1) 1477 Remote and Tag.....	5,695.00
	95 GPM (360 LPM) Eductor Only.....	1,933.00
	95 GPM (360 LPM) Metering Panel Only.....	681.00
3097	<b>95 GPM Portable By-Pass Eductor</b> .....	◇2,118.00
	Eductor Conversion Kit for Styles 2950 and 2958.....	778.00
3120	<b>120 GPM Foam Nozzle without Pickup Tube</b> .....	◇1,242.00
3121	<b>120 GPM Foam Nozzle with Pickup Tube</b> .....	◇1,816.00
3125	<b>125 GPM Pyrolite® In-Line Eductor</b> .....	◇1,034.00
	Eductor with On-Board Foam Access.....	◇1,516.00
3126	<b>125 GPM Foam Truck System</b> 125 GPM (475 LPM) Truck Kit - 1 Tank Includes: Eductor, Foam Panel, (1) 2" (51 mm) Valve with built in Check Valve, (1) Check Valve, (2) 1" (25 mm) Valves, (4) 1477 Remotes with Tags.....	5,109.00
	2 Tank Same as One Tank with (1) Extra 1" (25 mm) Valve, (1) Check Valve, (1) 1477 Remote and Tag.....	5,695.00
	125 GPM (475 LPM) Eductor Only.....	1,879.00
	125 GPM (475 LPM) Metering Panel Only.....	681.00
3127	<b>125 GPM Portable By-Pass Eductor</b> .....	◇2,152.00
3128	<b>Off-Truck Foam Access Kit</b> .....	884.00
3250	<b>250 GPM Pyrolite® In-Line Eductor</b> .....	◇1,419.00
3293	<b>FireFox™ Electric Nozzle</b> 12V or 24V Low Flow Nozzle, Adjustable 30, 60, 95, 125 GPM (115, 230, 360, 475 LPM) Fixed 60, 95, 125, 150, 175, 200 GPM (230, 360, 475, 550, 660, 750 LPM).....	1,841.00

Style	Description	US\$ List Price
<b>3293</b>	<b>FireFox™ Electric Nozzle (cont.)</b> 12V or 24V Mid Flow Nozzle, Adjustable 125, 175, 250, 350 GPM (475, 660, 950, 1325 LPM) Fixed 250, 300, 375 GPM (950, 1140, 1420 LPM)..... 1,841.00 12V or 24V High Flow Nozzle, Fixed 350, 400, 450, 500 GPM (1325, 1525, 1700, 1900 LPM) ..... 2,077.00 <b>Nozzle Options:</b> Flat Disperse Pattern..... 107.00	
<b>3350</b>	<b>TuckAway™ Electric Monitor</b> 12V or 24V Monitor and Logic Box ..... 13,304.00 <b>TuckAway™ Options:</b> Wireless Remote Control..... 2,151.00 60410008 4 Switch, Standard* Functions plus Stow and Deploy ..... 1,154.00 60412002 Handheld Tether Controller with 30' (9.0m) coil cord and panel mount connection ..... 2,603.00 12V Auxiliary Battery with 4' (1.2 m) Cable..... 907.00 5177 Akromatic 1250 Nozzle ..... 2,338.00 <i>The full range of CAN enabled controls and their cabling can be found in the 60xx section of this guide, starting on page 17</i> <i>Above prices do not include cost of network cabling</i>	
<b>3351</b>	<b>TuckAway™ Bumper Turret with Auto Level</b> 12V or 24V Monitor and Logic Box ..... 16,046.00 <b>TuckAway™ Options:</b> Special Manual Override..... 1,747.00 Wireless Remote Control..... 2,151.00 60350009 Standard* joystick with trigger for valve ..... 1,748.00 Style 5177 Akromatic® Nozzle ..... 2,338.00 CAN Direction Indicator ..... 1,131.00 <i>The full range of CAN enabled controls and their cabling can be found in the 60xx section of this guide, starting on page 17</i> <i>Above prices do not include cost of network cabling</i>	
<b>3352</b>	<b>TuckAway™ Bumper Turret</b> 12V or 24V Monitor & Logic Box ..... Price on Application	
<b>3353</b>	<b>TuckAway™ Roof Turret</b> 12V or 24V Monitor & Logic Box ..... Price on Application	
<b>3354</b>	<b>TuckAway™ Roof Turret (Inverted Mount)</b> 12V or 24V Monitor & Logic Box ..... Price on Application	
<b>3356</b>	<b>Trident HFRT-10 High Flow Electric Turret</b> <b>Standard Turret with 3.5" NH Threaded Outlet</b> Monitor and Logic Box (12V or 24V)..... 23,457.00 <b>Standard Turret Nozzle Options:</b> 1577 Sabermaster™ 1250 Electric Nozzle..... 4,031.00 5075 Akromatic® 1250 Electric FD Nozzle ..... 2,404.00 5177 Akromatic® 1250 Nozzle ..... 2,338.00 5178 Akromatic® 2000 Electric Nozzle ..... 2,949.00 3624 Automatic Master Stream Foam Nozzle..... 13,249.00 3626 Foam Nozzle (1000 gpm [3800 lpm])..... 4,866.00 <b>Custom Options:</b> Custom Color for Turret (Red, Lime Yellow, White)..... 325.00 Rear Inlet Option (4" Fl, 4" or 5" Victaulic)..... 2,296.00 Low Profile Rear Inlet Option (4" Flange only)..... 2,296.00 Inside-the-Cab Manual Override..... 4,591.00 <b>Controller Options:</b> CAN Wireless Remote Control ..... 2,151.00 60350009 Standard* joystick with trigger for valve ..... 1,748.00 60350012 ARFF Joystick Provides Standard* joystick functions with trigger for valve and switches for Stow/Deploy, High/Low Flow, Oscillation Set/Pause/Resume, Dry Chem On/Off plus two momentary pushbuttons for Fog/Stream..... 2,603.00 60410008 4 Switch, Standard* Functions plus Stow and Deploy ..... 1,154.00 60410012 4 Switch, Standard* Functions plus Oscillation ..... 1,154.00 60410016 4 Switch, Standard* Functions plus Water ON/OFF..... 1,154.00	

\* Standard functions are stream/fog, right/left, raise/lower

Style	Description	US\$ List Price
<b>3356</b>	<b>Trident HFRT-10 High Flow Electric Turret (cont.)</b> 4 Switch, Auxiliary Functions only (Stow/Deploy, High/Low Flow, Oscillation On/Off, Water On/Off) to be used with 6035 Standard Joystick with trigger..... 1,580.00 60410014 4 Switch, Auxiliary Functions only (Stow/Deploy, CAFS Wet/Off/Dry, Oscillation On/Off, Water On/Off) to be used with 60350009 ..... 1,580.00 CAN Direction Indicator Module ..... 1,131.00 <i>The full range of CAN enabled controls and their cabling can be found in the 60xx section of this guide, starting on page 17</i> <i>Above prices do not include cost of network cabling</i>	
	<b>Dual Gallonage Turret w/Integrated Flanged Nozzle</b> <b>Available flow options:</b> 375/750 gpm (1500/3000 lpm) 500/1000 gpm (1900/3800 lpm) 600/1200 gpm (2250/4500 lpm) 660/1320 gpm (2500/5000 lpm) 750/1500 gpm (3000/6000 lpm) 1000/2000 gpm (3800/7600 lpm) Monitor and Logic Box (12V or 24V) and Dual Gallonage non-aspirated fog nozzle (specify flow)..... 37,656.00 Monitor and Logic Box (12V or 24V) and Dual Gallonage aspirated foam tube (specify flow up to 6000 lpm)..... 39,941.00 Monitor and Logic Box (12V or 24V) and Dual Gallonage aspirated foam tube (3800/7600 lpm)..... 43,622.00 <b>Custom Options:</b> Cowling (Black, includes lights with harness)..... 3,848.00 Custom Color for Cowling (Red, Lime Yellow, White)..... 1,219.00 Custom Color for Turret (Red, Lime Yellow, White)..... 325.00 Rear Inlet Option (4" Fl, 4" or 5" Victaulic)..... 2,296.00 Low Profile Rear Inlet Option (4" Flange only)..... 2,296.00 Inside-the-Cab Manual Override..... 4,591.00 <b>Controller Options:</b> CAN Wireless Remote Control ..... 2,151.00 60350009 Standard* joystick with trigger for valve ..... 1,748.00 60350012 ARFF Joystick Provides Standard* joystick functions with trigger for valve and switches for Stow/Deploy, High/Low Flow, Oscillation Set/Pause/Resume, Dry Chem On/Off plus two momentary pushbuttons for Fog/Stream..... 2,603.00 60410008 4 Switch, Standard* Functions plus Stow and Deploy ..... 1,154.00 60410012 4 Switch, Standard* Functions plus Oscillation ..... 1,154.00 60410016 4 Switch, Standard* Functions plus Water ON/OFF..... 1,154.00 60410014 4 Switch, Auxiliary Functions only (Stow/Deploy, High/Low Flow, Oscillation On/Off, Water On/Off) to be used with 6035 Standard Joystick with trigger ..... 1,580.00 60410018 4 Switch, Auxiliary Functions only (Stow/Deploy, CAFS Wet/Off/Dry, Oscillation On/Off, Water On/Off) to be used with 60350009 ..... 1,580.00 CAN Direction Indicator Module ..... 1,131.00 <i>The full range of CAN enabled controls and their cabling can be found in the 60xx section of this guide, starting on page 17</i> <i>Above prices do not include cost of network cabling</i>	
<b>3358</b>	<b>Trident HFRT-10 High Flow Manual Turret</b> ..... 21,062.00	
<b>3367</b>	<b>Air Aspirated Electric Roof Turret</b> ..... 48,325.00 Dry Chem Nozzle..... 3,990.00 Position Indicator ..... 1,131.00	
<b>3368</b>	<b>Air Aspirated Manual Roof Turret</b> ..... 32,957.00 Dry Chem Nozzle..... 3,990.00	
<b>3401</b>	<b>Universal Monitor Support Flange</b> for Pipe Extension Above the Deck ..... 299.00	
<b>3405</b>	<b>Upper Deck - For Use with Apollo™ Monitors Only</b> ..... 398.00 with Direct Mount ..... 836.00 with Switch and Direct Mount ..... 1,053.00 Direct Mount Only ..... 438.00	

Style	Description	US\$ List Price
3406	<b>Electric Riser for Flanged Monitors</b> .....	4,264.00
3414	<b>Apollo™ Single Inlet Portable Monitor</b> with Pipe and Quad Stacked Tips.....	5,135.00
	less Pipe and Quad Stacked Tips .....	4,014.00
	Liftoff Only.....	1,762.00
	Ground Base Only.....	2,252.00
	Spike Cover Kit.....	104.00
3416	<b>Apollo™ Single Inlet Portable and Deck Monitor</b> with Pipe and Quad Stacked Tips.....	5,550.00
	less Pipe and Quad Stacked Tips .....	4,429.00
	Direct Mount Only .....	415.00
	Liftoff Only.....	1,762.00
	Ground Base Only.....	2,252.00
	Spike Cover Kit.....	104.00
3418	<b>Apollo™ Electric Monitor</b> 12V or 24V Monitor with Onboard Electronics Includes Wireless Receiver and Oscillation Function.....	7,600.00
	<b>Nozzle Options:</b> Style 1577 1250 GPM (4800 LPM) Electric Nozzle.....	4,031.00
	Style 5177 1250 GPM (4800 LPM) Electric Nozzle.....	2,338.00
	Custom Color for Monitor (Black, Lime Yellow, White).....	325.00
	Wireless Handheld Controller.....	1,067.00
60410012	4 Switch, Standard* Functions plus Oscillation.....	1,154.00
60412002	Handheld Tether Controller with 30' (9.0m) coil cord and panel mount connection.....	2,603.00
	<i>The full range of CAN enabled controls and their cabling can be found in the 60xx section of this guide, starting on page 17</i>	
	<i>Above prices do not include cost of network cabling</i>	
3419	<b>Apollo PE™ Portable Electric Monitor</b> with Single Inlet Ground Base, 3505 Storage Bracket, Handheld Wireless Control, Panel Mount CAN Control, Truck Mount Flange, Truck Power Harness and 5177 Akromatic® Nozzle.....	15,341.00
	Apollo PE™ Liftoff Only.....	8,009.00
	<b>Monitor Options:</b> Dual Inlet Ground Base Only - 2 1/2" (65 mm) Inlets.....	2,022.00
	Dual Inlet Ground Base Only - 3" (75 mm) Inlets.....	2,123.00
	Single Inlet Ground Base Only.....	2,252.00
	Direct Mount Only .....	411.00
	Spare Battery Charging Kit, includes: Battery Pack, DC charging cable and mounting bracket.....	1,423.00
	Spare Battery Pack.....	1,335.00
	Truck Power Harness.....	37.00
	AC Charging Kit.....	165.00
	<b>Nozzle Options:</b> Style 5177 1250 GPM (4800 LPM) Electric Nozzle.....	2,338.00
	Style 3485 Mini Stream Shaper.....	281.00
	Style 2499 Quad Stack Tips.....	702.00
	<b>Control Options:</b> Handheld Wireless Control.....	1,067.00
60410012	4 Switch, Standard* Functions plus Oscillation.....	1,154.00
60412002	Handheld Tether Controller with 30' (9.0m) coil cord and panel mount connection.....	2,560.00
	<i>The full range of CAN enabled controls and their cabling can be found in the 60xx section of this guide, starting on page 17</i>	
	<i>Above prices do not include cost of network cabling</i>	
3421	<b>Apollo™ Dual-Inlet Portable Monitor</b> 2 1/2" (65 mm) Inlet with Pipe and Quad Stacked Tips.....	4,905.00
	2 1/2" (65 mm) Inlet less Pipe and Quad Stacked Tips.....	3,784.00
	3" (75 mm) Inlet with Pipe and Quad Stacked Tips .....	5,006.00
	3" (75 mm) Inlet less Pipe and Quad Stacked Tips .....	3,885.00
	Liftoff Only.....	1,762.00
	Ground Base Only - 2 1/2" (65 mm) Inlets .....	2,022.00
	Ground Base Only - 3" (75 mm) Inlets.....	2,123.00
	Spike Cover Kit.....	104.00

\* Standard functions are stream/fog, right/left, raise/lower

Style	Description	US\$ List Price
3423	<b>Dual Inlet Portable and Deck Monitor</b> 2 1/2" (65 mm) Inlet with Pipe and Quad Stacked Tips.....	5,320.00
	2 1/2" (65 mm) Inlet less Pipe and Quad Stacked Tips.....	4,199.00
	3" (75 mm) Inlet with Pipe and Quad Stacked Tips .....	5,420.00
	3" (75 mm) Inlet less Pipe and Quad Stacked Tips .....	4,300.00
	Direct Mount Only .....	415.00
	Liftoff Only.....	1,762.00
	Ground Base Only - 2 1/2" (65 mm) Inlets .....	2,022.00
	Ground Base Only - 3" (75 mm) Inlets.....	2,123.00
	Spike Cover Kit.....	104.00
3425	<b>Aries™ Pyrolite Monitor</b> .....	2,138.00
3426	<b>3" Apollo™ Single Waterway Monitor</b> with Pipe and Deluge Tip.....	2,732.00
	less Pipe and Deluge Tip.....	1,931.00
3428	<b>Rover™ Monitor Cart</b> .....	5,908.00
3429	<b>Apollo™ Deck Pipe</b> with Steering Wheel Control and Gas Spring.....	2,256.00
3430	<b>GP Manual Monitor</b> .....	1,505.00
	Style 487 GP Deluge Tip.....	189.00
	Style 489 Plain Deluge Tip.....	372.00
3431	<b>Apollo Hi-Riser™ Single Inlet Portable and Deck Monitor</b> with Liftoff, Direct Mount, Ground Base, Pipe, Quad Stacked Tips and Style 5160 Nozzle.....	9,218.00
	with Liftoff, Direct Mount, Ground Base, Pipe and Stacked Tips.....	7,662.00
	with Liftoff, Direct Mount, and Ground Base .....	6,541.00
	Liftoff and Direct Mount Only .....	4,289.00
	Hi-Riser Direct Mount Only .....	448.00
	Hi-Riser Stow Indicator Light .....	595.00
	Spike Cover Kit.....	104.00
3432	<b>Platform Monitor</b> .....	4,385.00
3433	<b>Apollo Hi-Riser™ Dual-Inlet Portable and Deck Monitor</b> with Liftoff, Direct Mount, Ground Base, Pipe, Quad Stacked Tips and Style 5160 Nozzle .....	8,988.00
	with Liftoff, Direct Mount, Ground Base, Pipe and Tips .....	7,432.00
	with Liftoff, Direct Mount and Ground Base .....	6,311.00
	Liftoff and Direct Mount Only .....	4,289.00
	Hi-Riser Direct Mount Only.....	448.00
	Hi-Riser Stow Indicator Light .....	595.00
	Spike Cover Kit.....	104.00
3436	<b>Apollo™ 4" Single Waterway Monitor</b> .....	5,849.00
3437	<b>Omega™ 4" Single Waterway Monitor</b> .....	6,029.00
3440	<b>DeckMaster™ Electric Monitor</b> 12V or 24V Monitor and Logic Box.....	11,718.00
	<b>DeckMaster Options:</b> Position Feedback.....	2,017.00
	Position Indicator including Position Feedback.....	3,141.00
	Style 3406 Electric Riser .....	4,264.00
	Custom Color for Monitor (Black, Lime Yellow, White).....	325.00
	<b>Nozzle Options:</b> Style 1577 1250 GPM (4800 LPM) Electric Nozzle.....	4,031.00
	Style 5177 1250 GPM (4800 LPM) Electric Nozzle.....	2,338.00
	<b>Control Options:</b> Wireless Remote Control.....	2,151.00
60410008	4 Switch, Standard* Functions plus Stow and Deploy .....	1,154.00
60412002	Handheld Tether Controller with 30' (9.0m) coil cord and panel mount connection.....	2,603.00
	<i>The full range of CAN enabled controls and their cabling can be found in the 60xx section of this guide, starting on page 17</i>	
	<i>Above prices do not include cost of network cabling</i>	



Style	Description	US\$ List Price
<b>3443</b>	<b>Mercury™ Quick Attack Monitor</b> Quick Attack Monitor, Mounting Bracket and Style 4445 Nozzle ..... ◇2,711.00 Quick Attack Monitor Only..... ◇1,850.00 Mounting Bracket .....200.00 <b>Mercury™ Options:</b> Style 1545 SaberMaster™ 500 Nozzle.....1,156.00 Style 4445 Fixed Gallonage Nozzle.....661.00 Style 4447 Adjustable Gallonage Nozzle.....745.00	
<b>3446</b>	<b>MercuryMaster 1000™</b> MercuryMaster 1000™ Monitor ..... ◇3,919.00 <b>MercuryMaster 1000™ Options:</b> Style 5147 Adjustable Flow Nozzle.....1,239.00 Style 5148 Oscillating Nozzle.....2,837.00 Style 5150 Automatic Nozzle.....1,404.00 Style 2498 Triple Stacked Tips.....636.00 Style 489 Deluge Tip.....396.00 Storage Bracket.....240.00	
<b>3450</b>	<b>Ultra High Pressure Bumper Turret</b> Includes Monitor, Logic Box, Joystick and Nozzle ..... 21,461.00	
<b>3460</b>	<b>Roof Turret with Integral Nozzle</b> .....12,558.00 Additional Charge for Style 3296 Dry Chem Nozzle.....3,870.00	
<b>3462</b>	<b>Forestry Monitor</b> 12V or 24V Monitor with Harness, Low- or Mid-Flow Nozzle, CAN Proportional Joystick w/20' harness .....7,115.00 12V or 24V - Monitor Only.....3,263.00 <b>Monitor Options:</b> 2" (51 mm) NPT Quick Disconnect.....419.00 12V or 24V Low Flow Nozzle, Adjustable 30, 60, 95, 125 (Fixed 60, 95, 125, 150, 175, 200).....1,841.00 12V or 24V Mid Flow Nozzle, Adjustable 125, 175, 250, 300 (Fixed 250, 300).....1,841.00 Flat Disperse Pattern .....107.00 Custom Color for Monitor (Black, Lime Yellow, White).....325.00 <b>Control Options:</b> 60350009 Standard* joystick with trigger for valve ..... 2,011.00 Wireless Remote Control (CAN Interface).....2,151.00 <b>Valve Options:</b> 2" (51 mm) Electric Valve (PIS x PIS; includes harness).....1,831.00 <b>See Page 14 for add on Foam Tubes</b>	
<b>3463</b>	<b>FireFox™ Electric Monitor</b> 12V or 24V Monitor, Logic Box, Low- or Mid-Flow Nozzle, CAN Joystick with Trigger, 2" (52 mm) Electric Valve and Quick Disconnect.....12,933.00 12V or 24V Monitor and Logic Box.....6,238.00 <b>FireFox™ Options:</b> 2" (51 mm) NPT Quick Disconnect.....419.00 Position Feedback.....2,017.00 Position Indicator including Position Feedback.....3,141.00 12V or 24V Low Flow Nozzle, Adjustable 30, 60, 95, 125 (Fixed 60, 95, 125, 150, 175, 200).....1,841.00 12V or 24V Mid Flow Nozzle, Adjustable 125, 175, 250, 350 (Fixed 250, 300, 375).....1,841.00 12V High Flow Nozzle, Fixed 350, 400, 450, 500.....2,077.00 Flat Disperse Pattern.....107.00 Dry Chem Nozzle.....1,905.00 Custom Color for Monitor (Black, Lime Yellow, White).....325.00 <b>Control Options:</b> 60410023 Wireless Remote Control.....2,151.00 60410008 3 Switch, Standard* Functions.....1,154.00 60410016 4 Switch, Standard* Functions plus Stow and Deploy .....1,154.00 60350009 4 Switch, Standard* Functions plus Water ON/OFF .....1,154.00 Standard* joystick with trigger for valve .....1,748.00	

\* Standard functions are stream/fog, right/left, raise/lower

Style	Description	US\$ List Price
<b>3463</b> 60350012	<b>FireFox™ Electric Monitor (cont.)</b> ARFF Joystick Provides Standard* joystick functions with trigger for valve and switches for Stow/Deploy, High/Low Flow, Oscillation Set/Pause/Resume, Dry Chem On/Off plus two momentary pushbuttons for Fog/Stream.....2,603.00 <i>The full range of CAN enabled controls and their cabling can be found in the 60xx section of this guide, starting on page 17 Above prices do not include cost of network cabling</i> <b>Valve Options:</b> 2" (51 mm) Electric Valve (PIS x PIS; includes harness).....1,831.00 2 1/2" (65 mm) Electric Valve (PIS x PIS; includes harness).....1,930.00 <b>See Page 14 for add on Foam Tubes</b>	
<b>3465</b>	<b>Bumper Turret with Auto Oscillation and Control Package</b> .....15,503.00 Bumper Turret with Auto Oscillation Control Package and Dry Chem Nozzle .....19,372.00 <b>Specify Harness Length:</b> Additional Charge for 8' (2.4 m) Harness.....347.00 12' (3.7 m) Harness.....519.00 25' (7.6 m) Harness .....628.00	
<b>3467</b>	<b>Electric Roof Turret</b> with Auto Oscillation and Joystick Control .....46,878.00 Additional Charge for Dry Chem Nozzle.....3,929.00 Position Indicator.....1,131.00	
<b>3468</b>	<b>Manual Roof Turret</b> .....30,257.00 Additional Charge for Dry Chem Nozzle.....3,929.00	
<b>3470</b>	<b>Gemini™ Manual Monitor - Pyrolite®</b> with Pipe and Deluge Tip.....5,870.00 less Pipe and Deluge Tip.....5,069.00	
<b>3471</b>	<b>Gemini™ Manual Monitor - Brass</b> with Pipe and Deluge Tip .....7,016.00 less Pipe and Deluge Tip.....5,962.00	
<b>3475</b>	<b>Gemini™ Hydraulic Monitor - Pyrolite®</b> with Akromatic® Nozzle Style 5055.....16,615.00 less Nozzle .....14,542.00	
<b>3476</b>	<b>Gemini™ Hydraulic Monitor - Brass</b> with Akromatic® Nozzle Style 5056 .....17,666.00 less Nozzle .....14,838.00	
<b>3479</b>	<b>Gemini™ Electric Monitor 12V Monitor and Logic Box</b> 12V or 24V Monitor and Logic Box.....13,730.00 Custom Color for Monitor (Black, Lime Yellow, White).....325.00 <b>Gemini™ Options:</b> Wireless Remote Control.....2,151.00 60410023 3 Switch, Standard* Functions.....1,154.00 60350009 Standard* joystick with trigger for valve .....1,748.00 60412002 Handheld Tether Controller with 30' (9.0m) coil cord and panel mount connection .....2,603.00 12V Auxiliary Battery with 4' (1.2 m) Cable.....907.00 <b>Nozzle Options:</b> Style 1577 SaberMaster™ 1250 Nozzle.....4,031.00 Style 5177 Akromatic® 1250 Nozzle.....2,338.00 <i>The full range of CAN enabled controls and their cabling can be found in the 60xx section of this guide, starting on page 17 Above prices do not include cost of network cabling</i>	
<b>3480</b>	<b>StreamMaster II™ 2000 GPM Electric Monitor</b> 12V or 24V Monitor and Logic Box.....7,974.00 Includes Position Feedback, Stow Functionality, Wireless Receiver and Obstacle Avoidance <b>StreamMaster II™ Options:</b> Position Indicator.....1,124.00 Style 3406 Electric Riser .....4,264.00 Custom Color for Monitor (Black, Lime Yellow, White).....325.00	

Style	Description	US\$ List Price
3480	<b>StreamMaster II™ 2000 GPM Electric Monitor (cont.)</b> <b>Nozzle Options:</b> Style 1577 1250 GPM (4800 LPM) Electric Nozzle.....4,031.00 Style 5177 1250 GPM (4800 LPM) Electric Nozzle.....2,338.00 Style 5178 2000 GPM (7600 LPM) Electric Nozzle.....2,949.00 <b>Control Options:</b> Wireless Remote Control .....1,067.00 60410008 4 Switch, Standard* Functions plus Stow and Deploy .....1,154.00 60410023 3 Switch, Standard* Functions.....1,154.00 60350009 Standard* joystick with trigger for valve .....1,748.00 60412002 Handheld Tether Controller with 30' (9.0m) coil cord and panel mount connection .....2,603.00 12V Auxiliary Battery with 4' (1.2 m) Cable .....907.00 <i>The full range of CAN enabled controls and their cabling can be found in the 60xx section of this guide, starting on page 17</i> <i>Above prices do not include cost of network cabling</i>	
3481	<b>StreamMaster II™ 2000 GPM Manual Monitor</b> .....4,835.00	
3482	<b>StreamMaster II™ 1250 GPM Electric Monitor</b> 12V or 24V Monitor and Logic Box .....7,468.00 Includes Position Feedback, Stow Functionality, Wireless Receiver and Obstacle Avoidance <b>StreamMaster II™ Options:</b> Position Indicator.....1,124.00 Style 3406 Electric Riser .....4,264.00 Custom Color for Monitor (Black, Lime Yellow, White).....325.00 <b>Nozzle Options:</b> Style 1577 1250 GPM (4800 LPM) Electric Nozzle.....4,031.00 Style 5177 1250 GPM (4800 LPM) Electric Nozzle.....2,338.00 <b>Control Options:</b> Wireless Remote Control .....1,067.00 60410008 4 Switch, Standard* Functions plus Stow and Deploy .....1,154.00 60410023 3 Switch, Standard* Functions.....1,154.00 60350009 Standard* joystick with trigger for valve .....1,748.00 60412002 Handheld Tether Controller with 30' (9.0m) coil cord and panel mount connection .....2,603.00 12V Auxiliary Battery with 4' (1.2 m) Cable .....907.00 <i>The full range of CAN enabled controls and their cabling can be found in the 60xx section of this guide, starting on page 17</i> <i>Above prices do not include cost of network cabling</i>	
3483	<b>StreamMaster II™ 1250 GPM Manual Monitor</b> .....4,835.00	
3485	<b>Mini Stream Shaper</b> <b>Pyrolite®</b> 1 1/2" (38 mm) .....187.00 2 1/2" (65 mm) .....281.00 3 1/2" (89 mm) .....325.00	
3488	<b>Discharge Pipe</b> <b>Pyrolite®</b> <b>Cast</b> <b>Chrome</b> 2 1/2" F x 2 1/2" M (65 x 65 mm) .....429.00.....509.00.....604.00 3 1/2" F x 2 1/2" M (89 x 65 mm) .....462.00.....562.00.....689.00 3 1/2" F x 3" M (89 x 75 mm) .....664.00.....689.00	
3489	<b>Shaper Tip</b> .....755.00	
3491	<b>Severe-Duty Stainless Steel Electric Monitor</b> 12V or 24V Monitor, Wiring Harness and Logic Box.....9,175.00 <b>Severe-Duty Options:</b> Style 488 Brass Discharge Pipe .....677.00 Style 489 Brass Smooth Bore Tip .....403.00 Style 4471 Brass AkroFoam™ 300-750 Electric Self Educting with Pickup Tube and Shutoff Valve .....5,506.00 Style 4462 Brass Electric Rampage.....3,283.00 Style 5177 Aluminum 250 - 750 GPM (950 - 2900 LPM) Electric Nozzle .....2,338.00 Style 3293 Aluminum Electric Nozzle Up to 500 GPM (1900 LPM).....2,077.00	

\* Standard functions are stream/fog, right/left, raise/lower

Style	Description	US\$ List Price
3491	<b>Severe-Duty Stainless Steel Electric Monitor (cont.)</b> <b>Control Options:</b> Wireless Remote Control .....2,151.00 60410023 3 Switch, Standard* Functions.....1,154.00 60410008 4 Switch, Standard* Functions plus Stow and Deploy .....1,154.00 60410016 4 Switch, Standard* Functions plus Water ON/OFF .....1,154.00 60350009 Standard* joystick with trigger for valve .....1,748.00 60350012 ARFF Joystick Provides Standard* joystick functions with trigger for valve and switches for Stow/Deploy, High/Low Flow, Oscillation Set/Pause/Resume, Dry Chem On/Off plus two momentary pushbuttons for Fog/Stream .....2,603.00 <i>The full range of CAN enabled controls and their cabling can be found in the 60xx section of this guide, starting on page 17</i> <i>Above prices do not include cost of network cabling</i>	
3492	<b>Severe-Duty Hydraulic Monitor</b> .....8,352.00 <b>Severe-Duty Options:</b> Style 4460 Brass Rampage™ 500 & 750 GPM (1900 & 2900 LPM) Twist Shutoff Manual .....1,027.00 Style 2156 Brass Black Widow® 400-750 GPM (1525 & 2900 LPM) Hydraulic .....1,771.00 Style 5056 Brass Akromatic® 400-750 GPM (1525 & 2900 LPM) Hydraulic Pressure Balanced .....2,828.00	
3493	<b>Tank and Equipment Wash Down System</b> .....Price on Application	
3499	<b>Master Stacked Tips</b> .....605.00	
3500	<b>Ultra-High Expansion Foam Generator with Eductor</b> .....4,180.00	
3501	<b>Direct Mount Cover</b> .....89.00	
3502	<b>Apollo™ Running Board Mount</b> .....110.00	
3503	<b>Apollo™ Top Mount</b> .....505.00	
3505	<b>Mount for Apollo™ Ground Base</b> .....110.00	
3522SPL	<b>Omega™ XPV Special Duty Monitor</b> .....Price On Application	
3523	<b>Omega™ XPV Monitor</b> .....3,126.00	
3524	<b>Omega™ SD Monitor</b> .....3,261.00	
3525	<b>Aries™ Brass Monitor</b> .....2,364.00 Additional Charge for Paint.....125.00	
3526	<b>Omega™ 3" Single Waterway Monitor</b> .....2,303.00	
3528	<b>Omega™ XP Monitor</b> .....1,784.00 Additional Charge for Paint.....125.00	
3529	<b>4-Way Manifold</b> .....1,750.00	
3530	<b>Manual Elevated Monitor</b> 10' (3 m) tower with Nozzle.....Price on Application 15' (4.6 m) tower with Nozzle .....Price on Application 20' (6.1 m) tower with Nozzle .....Price on Application <b>Nozzle Options:</b> Nozzle with 10' Cable .....2,238.00 Nozzle with 15' Cable.....2,279.00 Nozzle with 20' Cable .....2,326.00	
3531	<b>Oscillating Flange for Brass Monitor</b> .....5,875.00 Additional charge for paint (specify color).....225.00	
3570	<b>StreamMaster™ Manual Monitor - Pyrolite®</b> .....4,846.00	
3571	<b>StreamMaster™ Manual Monitor - Brass</b> .....6,375.00	

Style	Description	US\$ List Price
3572	<b>StreamMaster™ Electric Monitor - Brass</b> 12V or 24V Monitor and Logic Box .....15,474.00 Custom Color for Monitor (Black, Lime Yellow, White) .....325.00 <b>Nozzle Options:</b> Style 4462 Rampage Electric Severe Duty Master Stream Nozzle .....3,283.00 Style 4471 AkroFoam™ Severe Duty Master Stream Nozzle...5,038.00 <b>Control Options:</b> Wireless Remote Control .....2,151.00	
60410008	4 Switch, Standard* Functions plus Stow and Deploy .....1,154.00	
60410023	3 Switch, Standard* Functions .....1,154.00	
60350009	Standard* joystick with trigger for valve .....1,748.00	
60412002	Handheld Tether Controller with 30' (9.0m) coil cord and panel mount connection .....2,358.00 12V Auxiliary Battery with 4' (1.2 m) Cable .....907.00 <i>The full range of CAN enabled controls and their cabling can be found in the 60xx section of this guide, starting on page 17</i> <i>Above prices do not include cost of network cabling</i>	
3578	<b>StreamMaster™ Electric Monitor</b> 12V or 24V Monitor and Logic Box with Stow .....10,886.00 <b>StreamMaster™ Options:</b> Position Feedback .....2,017.00 Position Indicator including Position Feedback .....3,141.00 Style 3406 Electric Riser .....4,264.00 Custom Color for Monitor (Black, Lime Yellow, White) .....325.00 <b>Nozzle Options:</b> Style 1577 1250 GPM (4800 LPM) Electric Nozzle .....4,031.00 Style 5177 1250 GPM (4800 LPM) Electric Nozzle .....2,338.00 Style 5178 2000 GPM (7600 LPM) Electric Nozzle .....2,949.00 <b>Control Options:</b> Wireless Remote Control .....2,151.00	
60410008	4 Switch, Standard* Functions plus Stow and Deploy .....1,154.00	
60410023	3 Switch, Standard* Functions .....1,154.00	
60350009	Standard* joystick with trigger for valve .....1,748.00	
60412002	Handheld Tether Controller with 30' (9.0m) coil cord and panel mount connection .....2,603.00 12V Auxiliary Battery with 4' (1.2 m) Cable .....907.00 <i>The full range of CAN enabled controls and their cabling can be found in the 60xx section of this guide, starting on page 17</i> <i>Above prices do not include cost of network cabling</i>	
3580	<b>Renegade™ Electric Monitor</b> 12V or 24V - 5000 GPM (Monitor and Logic Box) .....30,405.00 Custom Color for Monitor (Black, Lime Yellow, White) .....325.00 <b>Control Options:</b> Wireless Remote Control .....2,151.00	
60410008	4 Switch, Standard* Functions plus Stow and Deploy .....1,154.00	
60410023	3 Switch, Standard* Functions .....1,154.00	
60350009	Standard* joystick with trigger for valve .....1,748.00	
60412002	Handheld Tether Controller with 30' (9.0m) coil cord and panel mount connection .....2,603.00 12V Auxiliary Battery with 4' (1.2 m) Cable .....907.00 <i>The full range of CAN enabled controls and their cabling can be found in the 60xx section of this guide, starting on page 17</i> <i>Above prices do not include cost of network cabling</i>	
	<b>Nozzle Options:</b> 5088 - Renegade™ 5000 Automatic .....13,242.00 2188 - Renegade™ Fixed Flow Nozzle .....12,333.00 2189 - Renegade™ Adjustable Flow Nozzle .....12,333.00	
3590	<b>Genesis™ Hydraulic Manual Monitor System</b> with Monitor less Nozzle .....23,966.00 with Monitor and 2156 Nozzle .....25,737.00 with Monitor and 5056 Nozzle .....26,794.00	
3595	<b>Genesis™ Electric Hydraulic Monitor System</b> .....Price on Application	
3598	<b>StreamMaster™ XT Electric Monitor</b> 12V or 24V Monitor with Stow and Logic Box .....11,110.00 Custom Color for Monitor (Black, Lime Yellow, White) .....325.00	

\* Standard functions are stream/fog, right/left, raise/lower

Style	Description	US\$ List Price
3598	<b>StreamMaster™ XT Electric Monitor (cont.)</b> <b>Nozzle Options:</b> Style 1577 1250 GPM (4800 LPM) Electric Nozzle .....4,031.00 Style 5177 1250 GPM (4800 LPM) Electric Nozzle .....2,338.00 Style 5178 2000 GPM (7600 LPM) Electric Nozzle .....2,949.00 <b>Control Options:</b> Wireless Remote Control .....2,151.00	
60410008	4 Switch, Standard* Functions plus Stow and Deploy .....1,154.00	
60410023	3 Switch, Standard* Functions .....1,154.00	
60350009	Standard* joystick with trigger for valve .....1,748.00	
60412002	Handheld Tether Controller with 30' (9.0m) coil cord and panel mount connection .....2,603.00 12V Auxiliary Battery with 4' (1.2 m) Cable .....907.00 <i>The full range of CAN enabled controls and their cabling can be found in the 60xx section of this guide, starting on page 17</i> <i>Above prices do not include cost of network cabling</i>	
3600	<b>Wireless Remote Control (Controller and Receiver) .....2,151.00</b> Handheld Controller Only .....1,067.00 Receiver Only .....1,084.00 Switch Interface Transmitter (SIT) .....1,067.00	
3601	<b>60 GPM Foam Nozzle with Pickup Tube .....◇1,091.00</b>	
3602	<b>60 GPM Foam Nozzle without Pickup Tube .....◇688.00</b>	
3620	<b>1 1/2" Low Expansion FireFox™ Foam Tube .....586.00</b>	
3621	<b>2 1/2" Low Expansion FireFox™ Foam Tube .....656.00</b>	
3622	<b>1 1/2" Medium Expansion FireFox™ Foam Tube .....838.00</b>	
3623	<b>Dual Flow Automatic Master Stream Foam Nozzle .....5,204.00</b>	
3624	<b>3 1/2" Dual Flow Master Stream Foam Nozzle .....13,249.00</b>	
3625	<b>Master Stream Foam Nozzle .....1,094.00</b>	
3626	<b>Master Stream Foam Nozzle less Jaws .....2,014.00</b> Manually Actuated Dispersion Jaw .....2,264.00 Air Actuated Dispersion Jaw .....3,552.00 Electrically Actuated Dispersion Jaw .....4,866.00	
3671	<b>Conquest™ Monitor Dual Handwheel (less nozzle) .....8,626.00</b>	
3678	<b>Remote Control Monitor System .....Price on Application</b>	
3679	<b>Conquest™ Monitor and Logic Box .....Price on Application</b>	
3690	<b>Storm™ Monitor with Style 5079 Nozzle .....17,639.00</b> less Nozzle .....14,385.00	
3698	<b>Storm™ Electric Programmable Monitor System .....Price on Application</b>	
3716	<b>1 1/2" Industrial Turbojet® Nozzle .....◇1,058.00</b>	
3718	<b>1 1/2" Industrial Turbojet® Nozzle .....◇1,084.00</b>	
3719	<b>1 1/2" Industrial Turbojet® Nozzle with Pistol Grip .....◇1,216.00</b>	
3721	<b>1 1/2" Industrial Turbojet® Nozzle with Pistol Grip .....◇1,155.00</b>	
3725	<b>2 1/2" Industrial Turbojet® Nozzle .....◇1,254.00</b>	
3747	<b>Excel™ 1000 Master Stream .....1,509.00</b>	
3771	<b>Conquest™ SST 1000 Monitor .....Price on Application</b>	



Style	Description	US\$ List Price
3778	<i>Conquest™ SST Monitor System</i> .....Price on Application	
3878	<i>Vanquish™ SST Monitor System</i> .....Price on Application	
3951	<i>95 GPM Foam Nozzle with Pickup Tube</i> ..... ◇1,307.00	
3952	<i>95 GPM Foam Nozzle without Pickup Tube</i> ..... ◇797.00	
4039	<i>AkroChem™ 1250 GPM Manual Nozzle</i> ..... 2,632.00	
4040	<i>AkroChem™ 1250 GPM Electric Nozzle</i> ..... 3,158.00	
4041	<i>AkroChem™ 2000 GPM Manual Nozzle</i> ..... 3,128.00	
4042	<i>AkroChem™ 2000 GPM Electric Nozzle</i> ..... 3,654.00	
4115	<i>1 1/2" Avenger™ Fixed Gallonage Nozzle</i> ..... ◇768.00	
4115HFX	with HydroFX™ Flow Indicator..... ◇1,164.00	
	ZT Conversion Kit..... ◇275.00	
4116	<i>1 1/2" Avenger™ Fixed Gallonage Nozzle with Pistol Grip</i> ..... ◇768.00	
4116HFX	with HydroFX™ Flow Indicator..... ◇1,164.00	
4445	<i>Mercury™ Nozzle 500 GPM Fixed Gallonage</i> ..... 661.00	
4447	<i>Mercury™ Nozzle 500 GPM Adjustable Gallonage</i> ..... 745.00	
4450	<i>Aquastream™ Master Stream with Teeth - Brass</i> ..... 781.00	
4452	<i>Aquastream™ Master Stream with Teeth - Pyrolite®</i> ..... 635.00	
4460	<i>Rampage™ Master Stream with Twist Shutoff</i> ..... 1,027.00	
4461	<i>Rampage™ Master Stream</i> ..... 1,034.00	
4462	<i>Rampage™ Electric Master Stream</i> (Must specify standard or Severe Duty Series)..... 3,283.00	
4470	<i>AkroFoam™ Brass Master Stream Nozzle with Pickup Tube</i> ..... 1,884.00	
	AkroFoam™ Master Stream Nozzle with Pickup Tube and Valve..... 2,037.00	
	AkroFoam™ Master Stream Nozzle with Quick Connect Pickup Tube and Metering Head..... 2,521.00	
	AkroFoam™ Master Stream Nozzle only..... 1,566.00	
	Optional Foam Shutoff..... 153.00	
	Optional Drum Kit..... 130.00	
4471	<i>AkroFoam™ Brass Master Stream Electric Nozzle with Pickup Tube</i> ..... 5,353.00	
	AkroFoam™ Master Stream Nozzle with Pickup Tube and Valve..... 5,506.00	
	AkroFoam™ Master Stream Nozzle with Quick connect Pickup Tube and Metering Head..... 6,216.00	
	AkroFoam™ Master Stream Nozzle only (Must specify standard or Severe Duty Series)..... 5,038.00	
	Optional Foam Shutoff..... 153.00	
	Optional Drum Kit..... 130.00	
4473	<i>AkroFoam™ SST 1000 Electric Master Stream Nozzle</i> .....Price on Application	
4474	<i>AkroFoam™ SST 2000 Electric Master Stream Nozzle</i> .....Price on Application	
4475	<i>AkroFoam™ Pyrolite® Master Stream Nozzle with Pickup Tube and Metering Head</i> ..... 2,187.00	
	AkroFoam™ Master Stream Nozzle less Pickup Tube..... 1,232.00	
	Optional Foam Shutoff..... 153.00	
	Optional Drum Kit..... 130.00	

Style	Description	US\$ List Price
4476	<i>AkroFoam™ SST 1000 Manual Master Stream Nozzle</i> .....Price on Application	
4478	<i>AkroFoam™ 2000 GPM Master Stream Nozzle with Pickup Tube</i> ..... 2,658.00	
	AkroFoam™ 2000 GPM Master Stream Nozzle with Pickup Tube and Foam Shutoff Valve..... 2,811.00	
	AkroFoam™ 2000 GPM Master Stream Nozzle only..... 2,361.00	
	AkroFoam™ 2000 GPM Master Stream with Metering Head and Pickup Tube..... 3,428.00	
4480	<i>AkroFoam™ Pyrolite® Master Stream Electric Nozzle with Pickup Tube and Metering Head</i> ..... 4,133.00	
	AkroFoam™ Master Stream Nozzle less Pickup Tube (Must specify standard or Severe Duty Series)..... 3,158.00	
	Optional Foam Shutoff..... 153.00	
	Optional Drum Kit..... 130.00	
4712	<i>1" Assault™ Nozzle with Pistol Grip and Molded Teeth</i> ..... ◇955.00	
4713	<i>1" Assault™ Nozzle with Molded Teeth</i> ..... ◇831.00	
4714	<i>1 1/2" Assault™ Tip with Molded Teeth</i> ..... 631.00	
	Baffle Replacement Kit..... 42.00	
4715	<i>1 1/2" Assault™ Nozzle with Molded Teeth</i> ..... ◇827.00	
4715HFX	with HydroFX™ Flow Indicator..... ◇1,223.00	
	Baffle Replacement Kit..... 42.00	
	ZT Conversion Kit..... ◇275.00	
4715ZT	<i>1 1/2" Assault™ Zero Torque™ Nozzle with Molded Teeth</i> ..... ◇997.00	
	Baffle Replacement Kit..... 42.00	
4716	<i>1 1/2" Assault™ Breakapart Nozzle with Molded Teeth</i> ..... ◇1,087.00	
	Baffle Replacement Kit..... 42.00	
4717	<i>1 1/2" Assault™ Tip with Twist Shutoff with Molded Teeth</i> ..... 652.00	
	Baffle Replacement Kit..... 42.00	
4718	<i>1 1/2" Assault™ Breakapart Nozzle with Pistol Grip and Molded Teeth</i> ..... ◇1,168.00	
	Baffle Replacement Kit..... 42.00	
4720	<i>1 1/2" Assault™ Nozzle with Pistol Grip and Molded Teeth</i> ..... ◇926.00	
4720HFX	with HydroFX™ Flow Indicator..... ◇1,322.00	
	Baffle Replacement Kit..... 42.00	
4801	<i>1" Assault™ Nozzle with Spinning Teeth</i> ..... ◇820.00	
	Baffle Replacement Kit..... 42.00	
4802	<i>1" Assault™ Nozzle with Pistol Grip and Spinning Teeth</i> ..... ◇907.00	
	Baffle Replacement Kit..... 42.00	
4803	<i>1" Assault™ Tip with 1 1/2" Inlet</i> ..... 592.00	
	Baffle Replacement Kit..... 42.00	
4804	<i>1" Assault™ Tip with Spinning Teeth</i> ..... ◇585.00	
	Baffle Replacement Kit..... 42.00	
4808	<i>Ultra High Pressure Nozzle with Pistol Grip and No Teeth 1500 max PSI</i> ..... 1,328.00	
4812	<i>1" Assault™ Nozzle with Pistol Grip and Spinning Teeth</i> ..... ◇936.00	
4813	<i>1" Assault™ Nozzle with Spinning Teeth</i> ..... ◇831.00	

Prices are for U.S. domestic resale and do not include International Tariffs, Taxes and Shipping  
 ◇ : denotes a \$68.00 per inlet upcharge if fitted with British Instantaneous (BIM or BIF), Japanese Instantaneous (JIM or JIF), or Storz connections

Style	Description	US\$ List Price
4814	<b>1 1/2" Assault™ Tip with Spinning Teeth</b> ..... 626.00 Baffle Replacement Kit ..... 42.00	
4815	<b>1 1/2" Assault Nozzle with Spinning Teeth</b> ..... ◇803.00 with HydroFX™ Flow Indicator ..... ◇1,199.00 Baffle Replacement Kit ..... 42.00 ZT Conversion Kit ..... ◇275.00	
4815HFX		
4815E	<b>1 1/2" Electrical Assault™ Nozzle with Spinning Teeth</b> ..... ◇803.00	
4815ZT	<b>1 1/2" Assault™ Zero Torque™ Nozzle with Spinning Teeth</b> ..... ◇973.00 Baffle Replacement Kit ..... 42.00	
4816	<b>1 1/2" Assault™ Breakapart Nozzle with Spinning Teeth</b> ..... ◇1,061.00 Baffle Replacement Kit ..... 42.00	
4817	<b>1 1/2" Assault™ Tip with Twist Shutoff and Spinning Teeth</b> ..... 626.00 Baffle Replacement Kit ..... 42.00	
4818	<b>1 1/2" Assault™ Breakapart Nozzle with Pistol Grip and Spinning Teeth</b> ..... ◇1,142.00 Baffle Replacement Kit ..... 42.00	
4819	<b>1 1/2" Assault™ Breakapart Nozzle with Spinning Teeth</b> ..... ◇1,135.00 Baffle Replacement Kit ..... 42.00	
4820	<b>1 1/2" Assault™ Nozzle with Pistol Grip and Spinning Teeth</b> ..... ◇892.00 with HydroFX™ Flow Indicator ..... ◇1,288.00 Baffle Replacement Kit ..... 42.00	
4820HFX		
4820E	<b>1 1/2" Electrical Assault™ Nozzle with Pistol Grip and Spinning Teeth</b> ..... ◇892.00	
4821	<b>1 1/2" Assault™ Breakapart Nozzle with Pistol Grip and Spinning Teeth</b> ..... ◇1,159.00 Baffle Replacement Kit ..... 42.00	
4822	<b>1 1/2" High-Range Assault™ Nozzle with Spinning Teeth</b> ..... ◇1,030.00 with HydroFX™ Flow Indicator ..... ◇1,426.00 Baffle Replacement Kit ..... 42.00 ZT Conversion Kit ..... ◇275.00	
4822HFX		
4822ZT	<b>1 1/2" High-Range Assault™ Zero Torque Nozzle with Spinning Teeth</b> ..... ◇1,200.00 Baffle Replacement Kit ..... 42.00	
4823	<b>1 1/2" High-Range Assault™ Nozzle with Pistol Grip and Spinning Teeth</b> ..... ◇1,074.00 with HydroFX™ Flow Indicator ..... ◇1,470.00 Baffle Replacement Kit ..... 42.00	
4823HFX		
4824	<b>1 1/2" High-Range Assault™ Tip with Spinning Teeth</b> ..... 779.00 Baffle Replacement Kit ..... 42.00	
4825	<b>2 1/2" High-Range Assault™ Nozzle with Spinning Teeth</b> ..... ◇1,092.00 with HydroFX™ Flow Indicator ..... ◇1,488.00 Baffle Replacement Kit ..... 42.00 ZT Conversion Kit ..... ◇275.00	
4825HFX		
4825ZT	<b>2 1/2" High-Range Assault™ Zero Torque Nozzle with Spinning Teeth</b> ..... ◇1,262.00 Baffle Replacement Kit ..... 42.00	

Style	Description	US\$ List Price
4826	<b>2 1/2" High-Range Assault™ Nozzle with Pistol Grip and Spinning Teeth</b> ..... ◇1,181.00 with HydroFX™ Flow Indicator ..... ◇1,577.00 Baffle Replacement Kit ..... 42.00	
4826HFX		
4827	<b>1 1/2" High-Range Assault™ Tip with Twist Shutoff and Spinning Teeth</b> ..... 779.00 Baffle Replacement Kit ..... 42.00	
4830	<b>2 1/2" High-Range Assault™ Tip with Axial Playpipe</b> ..... ◇1,813.00 Baffle Replacement Kit ..... 42.00	
4834	<b>1 1/2" High-Range Assault™ Breakapart Nozzle with Pistol Grip</b> ..... ◇1,332.00 Baffle Replacement Kit ..... 42.00	
4835	<b>1 1/2" High-Range Assault™ Breakapart Nozzle with 1 1/2" Inlet</b> ..... ◇1,288.00 Baffle Replacement Kit ..... 42.00	
4836	<b>2 1/2" High-Range Assault™ Breakapart Nozzle with Pistol Grip</b> ..... ◇1,453.00 with HydroFX™ Flow Indicator ..... ◇1,849.00 Baffle Replacement Kit ..... 42.00	
4836HFX		
4837	<b>2 1/2" High-Range Assault™ Tip with Twist Shutoff and Spinning Teeth</b> ..... 834.00 Baffle Replacement Kit ..... 42.00	
4838	<b>2 1/2" High-Range Assault™ Breakapart Nozzle</b> ..... ◇1,412.00 with HydroFX™ Flow Indicator ..... ◇1,808.00 Baffle Replacement Kit ..... 42.00	
4838HFX		
4862	<b>Mid-Range Assault™ Nozzle</b> ..... ◇912.00 with HydroFX™ Flow Indicator ..... ◇1,308.00 Baffle Replacement Kit ..... 76.00 ZT Conversion Kit ..... ◇275.00	
4862HFX		
4862ZT	<b>Mid-Range Assault™ Zero Torque™ Nozzle</b> ..... ◇1,082.00 Baffle Replacement Kit ..... 76.00	
4863	<b>Mid-Range Assault™ Nozzle with Pistol Grip</b> ..... ◇912.00 with HydroFX™ Flow Indicator ..... ◇1,308.00 Baffle Replacement Kit ..... 76.00	
4863HFX		
4864	<b>Mid-Range Assault™ Breakapart Nozzle</b> ..... ◇1,192.00 Baffle Replacement Kit ..... 76.00	
4865	<b>Mid-Range Assault™ Breakapart Nozzle with Pistol Grip</b> ..... ◇1,236.00 Baffle Replacement Kit ..... 76.00	
4866	<b>Mid-Range Assault™ Tip</b> ..... 668.00 Baffle Replacement Kit ..... 76.00	
4867	<b>Mid-Range Assault™ Tip with Twist Shutoff</b> ..... 683.00 Baffle Replacement Kit ..... 76.00	
5051	<b>Akromatic® 1000 Manual Master Stream Nozzle - Brass</b> ..... 1,847.00	
5055	<b>Akromatic® 1000 Hydraulic Master Stream Nozzle - Pyrolite®</b> ..... 2,073.00	
5056	<b>Akromatic® 1000 Hydraulic Master Stream Nozzle - Brass</b> ..... 2,828.00	
5071	<b>Akromatic® 2000 Master Stream Nozzle</b> ..... 2,567.00	

Style	Description	US\$ List Price
5075	<b>Akromatic® 1250 Electric Master Stream Nozzle</b> .....	2,404.00
5079	<b>Storm™ 2000 Automatic Master Stream Nozzle</b> .....	3,254.00
5088	<b>Renegade™ 5000 Electric Master Stream Nozzle</b> .....	13,242.00
5098	<b>Akromatic® 2000 Electric Master Stream Nozzle - Brass</b> .....	Price on Application
5147	<b>MercuryMaster™ Adjustable Flow Nozzle</b> .....	1,239.00
5148	<b>MercuryMaster™ Oscillating Nozzle</b> .....	2,837.00
5150	<b>MercuryMaster™ Automatic Nozzle</b> .....	1,404.00
5160	<b>Akromatic® 1250 Master Stream Nozzle</b> .....	1,556.00
5161	<b>Brass Akromatic® 1250 Master Stream Nozzle</b> .....	2,228.00
	Add for paint .....	225.00
5170	<b>Akromatic® 2000 Master Stream Nozzle</b> .....	2,161.00
5176	<b>Excel™ Selectable Gallonage Electric Master Stream Nozzle</b> .....	2,368.00
5177	<b>Akromatic® 1250 Electric Master Stream Nozzle</b> .....	2,338.00
5178	<b>Akromatic® 2000 Electric Master Stream Nozzle</b> .....	2,949.00

***CAN Universal II Accessories and Controls***

6032	<b>CAN Universal II Logic Box</b> Specify Monitor Style Number .....	1,926.00
6033	<b>Electric Riser Controller</b> .....	1,393.00
6035	<b>CAN Proportional Joystick</b> 60350009 Standard* joystick with trigger for valve .....	1,748.00
60350010	Riot Control Joystick Provides Standard* joystick functions with trigger for valve plus two momentary pushbuttons for Pulse/Stream Selection.....	1,891.00
60350012	ARFF Joystick Provides Standard* joystick functions with trigger for valve and switches for Stow/Deploy, High/Low Flow, Oscillation Set/Pause/Resume, Dry Chem On/Off plus two momentary pushbuttons for Fog/Stream .....	2,603.00
60350017	Point/Aim Synchronous Joystick Provides visual representation of monitor position Used only with monitors that have position feedback option Palm Grip provides Right/Left/Up/Down functions, two momentary pushbuttons for Fog/Stream and two momentary pushbuttons provide ambidextrous control for Discharge On/Off.....	2,603.00
	* Standard functions are stream/fog, right/left, raise/lower	
6036	<b>CAN Direction Indicator</b> Specify Portrait (vertical) or Landscape (horizontal).....	1,131.00
6037	<b>CAN Wireless Interface</b> 2.4 Ghz (for use with Style 3600 Handheld or SIT).....	1,084.00
	900 Mhz (for use with Style 3600 Handheld or SIT).....	1,084.00
	See Page 14 for Style 3600 options	
6039	<b>CAN Input/Output Module</b> 60390005 Can Valve Input/Output Module Provides inputs for external OEM Open/Close switches and outputs for external valve Close/Open indicators.....	661.00
60390007	Can Ladder Input/Output Module Provides inputs for external OEM Ladder Limit switch (safe zone) and outputs for Discharge Valve Solenoid and "Monitor in Safe Zone" indicators.....	661.00

Style	Description	US\$ List Price
6041	<b>CAN Toggle Switch Station</b>	
60410008	4 Switch, Standard* Functions plus Stow and Deploy .....	1,154.00
60410012	4 Switch, Standard* Functions plus Oscillation.....	1,154.00
60410014	4 Switch, Auxiliary Functions only (Stow/Deploy, High/Low Flow, Oscillation On/Off, Water On/Off) to be used with 60350009 .....	1,580.00
60410016	4 Switch, Standard* Functions plus Water ON/OFF .....	1,154.00
60410018	4 Switch, Auxiliary Functions only (Stow/Deploy, CAFS Wet/Off/Dry, Oscillation On/Off, Water On/Off) to be used with 60350009 .....	1,580.00
60410020	OEM Switch Interface Allows connection of OEM switches to CAN network Inputs available for Fog/Stream, Left/Right, Raise/Lower, Oscillation Set/Pause/Resume CAFS Dry/Wet/Water, Discharge On/Off Supports Stow/Deploy function, output for Monitor Status LED.....	605.00
60410022	OEM Switch Interface Allows connection of OEM switches to CAN network Inputs available for Fog/Stream, Left/Right, Raise/Lower, Oscillation Set/Pause/Resume, Stow/Deploy, Discharge On/Off, output for Monitor Status LED.....	605.00
60410023	3 Switch, Standard* Functions.....	1,154.00
60411000	3 Switch Special plus Mini Joystick Joystick provides right/left/up/down, three switches provide Stow/Deploy, Oscillation Set/Pause/Resume, and Fog/Stream.....	1,580.00
60411003	2 Switch Special plus Mini Joystick Joystick provides right/left/up/down, two switches provide Stow/Deploy and Fog/Stream .....	1,580.00
60411005	2 Switch Special plus Mini Joystick Joystick provides right/left/up/down, two switches provide Discharge On/Off and Fog/Stream.....	1,580.00
60411006	2 Switch Special plus Mini Joystick with offset connector Joystick provides right/left/up/down, two switches provide Discharge On/Off and Fog/Stream.....	1,580.00
60412002	Handheld Tether Controller with 30 ft. (9 m) coil cord Mini joystick provides right/left/up/down, four switches provide Fog/Stream, Stow/Deploy, Oscillation Set/Pause/Resume, Discharge On/Off including Panel Mount Interface (60510005) .....	2,603.00
60412007	Handheld Tether Controller with 30 ft. (9 m) coil cord Six toggle switches provide Right/Left, Up/Down, Fog/Stream, Stow/Deploy, Oscillation Set/Pause/Resume, Discharge On/Off including Panel Mount Interface (60510005) .....	2,603.00
60412008	Handheld Tether Controller with 30 ft. (9 m) coil cord Four toggle switches provide Right/Left, Up/Down, Fog/Stream, Stow/Deploy, Oscillation Set/Pause/Resume, including Panel Mount Interface (60510005) .....	2,164.00
	* Standard functions are stream/fog, right/left, raise/lower	
6045	<b>Apollo PE™ Battery Box</b> .....	1,335.00
6051	<b>CAN Interface Modules</b>	
60510002	CAN to CAN Open Interface Module Provides interface to apparatus using CAN Open network to J1939 CAN monitor network.....	766.00
60510005	CAN to CAN Tether Interface Module Provides panel mount CAN tether connector and interface to CAN monitor network, included with 60412xxx above.....	422.00
	<b>CAN Universal II Cable Components</b>	
721565	CAN Device Cable, 20 ft. (6 m), for single control device connection to onboard controller.....	263.40
721570	CAN Extension Harness, 20 ft. (6 m).....	166.44
721572	CAN Extension Harness, 3 ft. (.91 m).....	102.42
721573	CAN Extension Harness, 5 ft. (1.5 m).....	109.42
721574	CAN Extension Harness, 10 ft. (3 m).....	128.03

Style	Description	US\$ List Price
<b>CAN Universal II Cable Components (cont.)</b>		
721575	CAN Extension Harness, 40 ft. (12 m).....	242.06
721579	CAN Monitor Control Device Harness with Power Provides CAN plus power and ground for CAN joystick, toggle switch station, or direction indicator.....	108.25
721580	CAN Monitor Wireless Interface Harness Provides CAN plus power and ground for CAN wireless module.....	86.14
721582	Universal II JI Interface Harness Provides access to Universal II logic box JI input connector.....	222.28
721589	CAN Monitor Interface Harness Provides CAN (4 pin to 3 pin) less power.....	107.52
721592	Monitor Extension Harness Connects to existing monitor harness to provide 8 additional feet of length between the monitor and Universal II logic box (2 per monitor max).....	228.79
721615	Navigator™ Pro Display Pigtail Harness - includes CAN connection, power in and power out.....	127.81
721617	Navigator™ Pro Motor Pigtail Harness - includes CAN connection, power in and CAFS solenoid connection.....	73.33
721659	CAN Extension Harness, 6 in. (15 m).....	92.27
742205	CAN Termination Plug One required at each end of CAN network.....	15.07
758306	CAN Network Tee One required at each CAN device.....	22.16
<b>7592</b>	<b>Piggy-Back Remote Control 2 1/2"</b> for SZ Handles (One Side).....	747.00
<b>7593</b>	<b>Piggy-Back Remote Control 2 1/2"</b> for TS and TSC Handles (One Side).....	455.00
<b>7594</b>	<b>Piggy-Back Remote Control 2 1/2"</b> for TS and TSC Handles (Both Sides).....	515.00
<b>7675</b>	<b>Slo-Cloz™ for Non-Locking Valves</b> .....	384.00
<b>7875</b>	<b>Slo-Cloz™ for Locking Valves</b> .....	324.00
<b>7725</b>	<b>Lightweight Apparatus Swing-Out™ Valve</b>	
	2 1/2" (65 mm) Aluminum Valve with PIS X PIS X TSC.....	746.00
	2 1/2" (65 mm) Aluminum Valve with PIS X MESIS X TSC.....	938.00
	2 1/2" (65 mm) Aluminum Valve less Adapter with MESIS X TSC.....	821.00
	2 1/2" (65 mm) Aluminum Valve with FIS X MIS X TSC.....	846.00
<b>7940-60</b>	<b>Butterfly Valve, 4", 4.5", 5", 6"</b> .....See Valve Guide, Page 31	
<b>7980</b>	<b>Black Max™ Piston Intake Valve</b> .....2,246.00 <b>Additional Charge for:</b>	
	4", 5" and 6" Storz Cap and Chain (102, 127 and 153 mm).....	221.00
	4" or 5" Full-Time Swivel Storz Inlet (102 or 127 mm).....	327.00
	6" Storz Inlet (153 mm).....	424.00
	Air Bleeder Diversion Hoses.....	244.00
<b>8620</b>	<b>2" Swing-Out™ Valve, Metal Ball</b> .....See Valve Guide, Page 20	
<b>8625</b>	<b>2.5" Swing-Out™ Valve, Metal Ball</b> .....See Valve Guide, Page 20	
<b>8630</b>	<b>3" Swing-Out™ Valve, Metal Ball</b> .....See Valve Guide, Page 20	
<b>8635</b>	<b>3.5" Swing-Out™ Valve, Metal Ball</b> .....See Valve Guide, Page 20	
<b>8803</b>	<b>Field Service/Conversion Kit with Metal Ball for Styles 7610, 7810, 8810 and 8910 Swing-Out™ Valves</b> .....	87.00
<b>8804</b>	<b>Field Service/Conversion Kit with Metal Ball for Styles 7615, 7815, 8815 and 8915 Swing-Out™ Valves</b> .....	110.00
<b>8810</b>	<b>1" Swing-Out™ Valve, Metal Ball</b> .....See Valve Guide, Page 20	
<b>8815</b>	<b>1.5" Swing-Out™ Valve, Metal Ball</b> .....See Valve Guide, Page 20	

Style	Description	US\$ List Price
<b>8820</b>	<b>2" Swing-Out™ Valve, Metal Ball</b> .....See Valve Guide, Page 20	
<b>8825</b>	<b>2.5" Swing-Out™ Valve, Metal Ball</b> .....See Valve Guide, Page 20	
<b>8830</b>	<b>3" Swing-Out™ Valve, Metal Ball</b> .....See Valve Guide, Page 20	
<b>8835</b>	<b>3.5" Swing-Out™ Valve, Metal Ball</b> .....See Valve Guide, Page 20	
<b>8840</b>	<b>4" Swing-Out™ Valve, Flat Ball</b> .....See Valve Guide, Page 20	
<b>8903</b>	<b>G2 Field Service Kit with Composite Ball for Style 7610, 7810, 8810, 8910</b> .....	82.00
<b>8904</b>	<b>G2 Field Service Kit with Composite Ball for Style 7615 7815, 8815, 8915</b> .....	104.00
<b>8905</b>	<b>G2 Field Service Kit with Composite Ball for Style 7620, 7820, 8620, 8820, 8920</b> .....	132.00
<b>8906</b>	<b>G2 Field Service Kit with Composite Ball for Style 7625, 7825, 8625, 8825, 8925</b> .....	133.00
<b>8907</b>	<b>G2 Field Service Kit with Composite Ball for Styles 7630, 7830, 7635, 7835, 8630, 8830, 8635, 8835, 8930, 8935</b> .....	193.00
<b>8908</b>	<b>G2 Field Service Kit with Composite Ball for Styles 7840, 8940</b> .....	224.00
<b>8910</b>	<b>1" Swing-Out™ Valve, Composite Ball</b> .....See Valve Guide, Page 20	
<b>8915</b>	<b>1.5" Swing-Out™ Valve, Composite Ball</b> .....See Valve Guide, Page 20	
<b>8920</b>	<b>2" Swing-Out™ Valve, Composite Ball</b> .....See Valve Guide, Page 20	
<b>8925</b>	<b>2.5" Swing-Out™ Valve, Composite Ball</b> .....See Valve Guide, Page 20	
<b>8930</b>	<b>3" Swing-Out™ Valve, Composite Ball</b> .....See Valve Guide, Page 20	
<b>8935</b>	<b>3.5" Swing-Out™ Valve, Composite Ball</b> .....See Valve Guide, Page 20	
<b>8940</b>	<b>4" Swing-Out™ Valve, Composite Ball</b> .....See Valve Guide, Page 20	
<b>9001</b>	<b>Handle Replacement Kit for 1.5" Shutoffs</b> Fits 3/8" trunnion; specify color.....	★ 20.75
<b>9002</b>	<b>Handle Replacement Kit for 2.5" Shutoffs</b> Fits 7/16" trunnion; specify color.....	★ 20.75
<b>9003</b>	<b>Handle Replacement Kit for SSO SaberJet™</b> .....	★ 51.18
<b>9011</b>	<b>Heat Sensor with Laser Sight</b> .....762.00 Mini Heat Sensor with Laser Sight.....	371.00
<b>9106</b>	<b>Field Service Kit for Styles 1708, 1710</b> .....	109.00
<b>9108</b>	<b>Field Service Kit for Styles 1715, 1720, 4615, 4616</b> .....	94.00
<b>9110</b>	<b>Field Service Kit for Styles 1722, 1723, 1725, 1729, 4625, 4626, 4629</b> .....	125.00
<b>9115</b>	<b>Field Service Kit for Styles 1701 and 1702 (Mfg. 1993-2000), 4612, 4613</b> .....	109.00
<b>9124</b>	<b>Field Service Kit for Style 810</b> .....	125.00
<b>9125</b>	<b>Field Service Kit for Style 815, 1480, 1481, 1581</b> .....	115.00
<b>9126</b>	<b>Field Service Kit for Style 820</b> .....	125.00
<b>9127</b>	<b>Field Service Kit for Style 825, 1482, 1483</b> .....	121.00
<b>9128</b>	<b>Field Service Kit for Style 828, 1582, 1583, 1828, 2582, 2583</b> .....	135.00
<b>9129</b>	<b>Field Service Kit for Style 830</b> .....	198.00
<b>9132</b>	<b>Handle Replacement Kit for 2581</b> Aluminum Handle (fits round trunnion).....	★ 13.99
	Polymer Handle (fits square trunnion).....	★ 17.41



Style	Description	US\$ List Price
9145	G2 Field Service/Conversion Kit with Metal Ball for Styles 7620, 7820, 8620, 8820 and 8920 Swing-Out™ Valves.....	141.00
9146	G2 Field Service/Conversion Kit with Metal Ball for Styles 7625, 7825, 8625, 8825 and 8925 Swing-Out™ Valves.....	143.00
9147	G2 Field Service/Conversion Kit with Metal Ball for Styles 7630, 7635, 7830, 7835, 8630, 8635, 8830, 8835 and 8930, 8935 Swing-Out™ Valves.....	206.00
9150	Field Service Kit for Styles 1110, 2110, 2111, 4510, 4511.....	109.00
9151	Field Service Kit for Styles 1115, 2115, 2116, 4507, 4508, 4512, 4513, 4515, 4516.....	94.00
9152	Field Service Kit for Styles 1125, 1128, 2126, 2127, 2129, 4525, 4526, 4529, 4530.....	124.00
9153	Field Service Kit for Style 2581, 2681.....	167.00
9154	Field Service Kit for Style 525.....	170.00
9155	Field Service Kit for Styles 3015, 3016, 3019, 3021.....	94.00
9156	Field Service Kit for Style 628.....	137.00
9158	Field Service Kit for Style 2130.....	74.00
9160	Field Service Kit for Styles 5115, 5116, 5120, 5121.....	125.00
9163	Field Service Kit for Style 2069.....	120.00
9164	Field Service Kit for Style 2074.....	178.00
9166	Field Service Kit for Style 8840.....	197.00
9168	Field Service Kit for Style 7980.....	146.00
9170	Field Service Kit for Style 3460.....	288.00
9171	Field Service Kit for Style 3461.....	179.00
9178	Field Service Kit for Styles 4712, 4713, 4715, 4720, 4812, 4813, 4815, 4820.....	94.00
9179	Field Service Kit for Styles 1762, 1763, 4822, 4823, 4825, 4826.....	125.00
9180	Field Service Kit for Styles 1701, 1702, 1704, 4801, 4802.....	94.00
9182	Field Service Kit for Styles 1522, 1523, 1525 and 1526.....	125.00
9183	Field Service Kit for Styles 1512, 1513, 1515 and 1520.....	94.00
9184	Field Service Kit for Styles 1532, 1533, 1535 and 1536.....	125.00
9190	Field Service Kit for Styles 3411, 3421, 3431.....	114.00
9191	Field Service Kit for Style 911.....	109.00
9194	Field Service Kit for 3467 3" Valve Assembly with Ball.....	198.00
9195	Field Service Kit for Style 3465.....	64.00
9196	Field Service Kit for Style 3466.....	71.00
9197	Field Service Kit for 3467 3" Complete Assembly.....	142.00
9198	Field Service Kit for 3467 3" Valve Assembly Less Ball.....	100.00
9199	Field Service Kit for 3467 Panel Cover S/A.....	52.00
9200	Tool Kit for Nozzles.....	345.00
9201	Parker® O-Lube.....	32.00
9202	Low-Temp Lubriplate® 10 oz.....	28.00

Style	Description	US\$ List Price
9203	Low-Temp Lubriplate® 14 1/2 oz.....	28.00
9204	Field Service Kit without Metal Ball for Styles 8620, 8820.....	36.00
9205	Field Service Kit without Metal Ball for Styles 8625, 8825.....	48.00
9206	Field Service Kit without Metal Ball for Styles 8630, 8635, 8830, 8835.....	51.00
9208	Field Service Kit without Metal Ball for Style 8810.....	36.00
9209	Field Service Kit without Metal Ball for Style 8815.....	36.00
9261	Eductor Conversion Kit for Styles 2609 & 2610.....	685.00
9292	Field Service Kit for Style 922.....	124.00
9296	Eductor Conversion Kit for Styles 2959 & 2960.....	729.00
9300	Flow/Pressure Meter with wiring harness, two cables, flow sensor and pressure transducer.....	2,366.00
9301	Portable Flow Meter.....	4,888.00
9323	<b>Navigator™ Pro Valve Controller</b> includes Controller and 10' Wiring Harness..... 747.00 Also available with 15' and 20' Wiring Harness <b>Valve Color Indicators</b> Kit including one set of each color (26 pieces)..... 54.00 Kit including 5 sets of single color (specify color)..... 21.00 1 set of single color (specify color)..... 4.00 <i>Navigator™ Pro Valve controllers are for use exclusively with the Navigator™ Pro electric valve actuator. For networked installation see page 17 for CAN cabling; use of a Controller as an Auxiliary unit requires a networked installation. Contact Customer Service for detailed ordering instructions. See Valve Pricing (page 20) for Electric Actuator.</i>	
9325	<b>Navigator™ Pro Valve Controller with Pressure Meter, Flow Meter and CAFS</b> includes Controller, 10' Wiring Harness, Pressure Transducer and Cable..... 1,658.00 Also available with 15' and 20' Wiring Harness includes Controller, 10' Wiring Harness, Flow Sensor, Pressure Transducer and 2 Cables..... 2,196.00 Also available with 15' and 20' Wiring Harness <b>Valve Color Indicators</b> Kit including one set of each color (26 pieces)..... 54.00 Kit including 5 sets of single color (specify color)..... 21.00 1 set of single color (specify color)..... 4.00 <i>Navigator™ Pro Valve controllers are for use exclusively with the Navigator™ Pro electric valve actuator. For networked installation see page 17 for CAN cabling; use of a Controller as an Auxiliary unit requires a networked installation. Contact Customer Service for detailed ordering instructions. See Valve Pricing (page 20) for Electric Actuator.</i>	
9437	Field Service Kit for Style 3437.....	263.00
9443	Field Service Kit for Style 3443.....	71.00
9515	Field Service Kit for Styles 3716, 3718, 3719, 3721, 1741.....	94.00
9525	Field Service Kit for Style 3425.....	74.00
9526	Field Service Kit for Styles 3426, 3526.....	74.00
9527	Field Service Kit for Styles 3427, 3527.....	74.00
91000	Fire Stream/Friction Loss Calculator.....	26.00
9900	FireCalc™ Pocket Calculator.....	52.00

**To place an order:** state the style number, inlet and outlet adapters needed (always list inlet adapter first) and the type of handle/actuator. All threaded adapters require thread information. Rigid female adapters are available only with tapered pipe thread (NPT). ***Hose threaded adapters will be supplied with National Hose (NH) thread unless otherwise specified.***

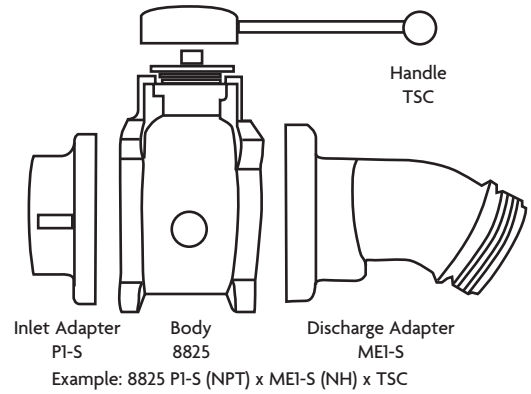
**8800 & 8600 Series Heavy-Duty Valves**

Style	Size	A	B		Body Sub Assembly Only List Price - US Dollars	
			R-1, TS, TSC	SZ		
Uses RI, TS or TSC Handles Only	8810	1" (25 mm)	1 7/8" (48 mm)	2 11/16" (68 mm)	-	160.52
	8815	1 1/2" (38 mm)	2 1/4" (57 mm)	3 1/16" (78 mm)	-	204.41
	8820	2" (51 mm)	3" (75 mm)	3 3/4" (95 mm)	4 5/32" (106 mm)	253.78
	8825	2 1/2" (65 mm)	3 1/2" (89 mm)	4 1/8" (105 mm)	4 3/16" (106 mm)	319.62
	8830	3" (75 mm)	4" (102 mm)	4 1/2" (114 mm)	4 9/16" (116 mm)	530.89
	8835	3 1/2" (89 mm)	4" (102 mm)	4 1/2" (114 mm)	4 9/16" (116 mm)	530.89
Uses SZ, RS Handles and Gear or Electric Actuators	8620	2" (51 mm)	3" (75 mm)	3 3/4" (95 mm)	4 5/32" (106 mm)	253.78
	8625	2 1/2" (65 mm)	3 1/2" (89 mm)	4 1/8" (105 mm)	4 3/16" (106 mm)	319.62
	8630	3" (75 mm)	4" (102 mm)	4 1/2" (114 mm)	4 9/16" (116 mm)	530.89
	8635	3 1/2" (89 mm)	4" (102 mm)	4 1/2" (114 mm)	4 9/16" (116 mm)	530.89

**8900 Series Heavy-Duty Valves (replaces 7600 and 7800 Series)**

Style	Size	A	B		Body Sub Assembly Only List Price - US Dollars	
			R-1, TS, TSC	SZ		
Uses RI, TS, TSC, RS and SZ Handles and Gear or Electric Actuators	8910	1" (25 mm)	1 7/8" (48 mm)	2 11/16" (68 mm)	-	159.10
	8915	1 1/2" (38 mm)	2 1/4" (57 mm)	3 1/16" (78 mm)	-	193.67
	8920	2" (51 mm)	3" (75 mm)	3 3/4" (95 mm)	4 5/32" (106 mm)	244.16
	8925	2 1/2" (65 mm)	3 1/2" (89 mm)	4 1/8" (105 mm)	4 3/16" (106 mm)	305.59
	8930	3" (75 mm)	4" (102 mm)	4 1/2" (114 mm)	4 9/16" (116 mm)	506.03
	8935	3 1/2" (89 mm)	4" (102 mm)	4 1/2" (114 mm)	4 9/16" (116 mm)	506.03

**Swing-Out™ Valve Body Sub Assembly With Actuator**

Style	Size	Gear Less Handwheel	Electric Less Controller*	Air
		List Price - US Dollars	List Price - US Dollars	List Price - US Dollars
8620	2" (51 mm)	735.24	1,792.30	-
8625	2 1/2" (65 mm)	768.17	1,856.32	-
8630	3" (75 mm)	976.67	2,130.49	-
8635	3 1/2" (89 mm)	976.67	2,130.49	-
8840	4" (102 mm)	1,416.98	2,708.71	2,441.03
8920	2" (51 mm)	725.62	1,782.68	-
8925	2 1/2" (65 mm)	754.14	1,842.29	-
8930	3" (75 mm)	951.81	2,105.63	-
8935	3 1/2" (89 mm)	951.81	2,105.63	-
8940	4" (102 mm)	1,416.98	2,708.71	2,441.03

\*See Styles 9323 and 9325 for Valve Controller options.







**Handles, Actuators and Accessories (List Price - US Dollars)**

Size	R-1	SZ	TS	TSC	Rack and Sector	PB-1	Handwheel Assembly for Local Actuation	Handwheel Assembly for Remote Actuation † (Less Handwheel)	Position Indicator with Handwheel	Slo Cloz™ for R/S and Non-Locking Valves	Slo Cloz for Tork Lok & Self Locking Valves
1" (25 mm)	39.80	-	76.83	116.61	-	-	-	-	-	-	-
1 1/2" (38 mm)	39.80	-	76.83	116.61	-	-	-	-	-	-	-
2" (51 mm)	60.40	160.52	87.82	137.20	-	-	144.05	613.17	647.46	-	325.14
2 1/2" (65 mm)	60.40	160.52	87.82	137.20	342.94	160.52	144.05	613.17	647.46	-	325.14
3" (75 mm)	60.40	160.52	87.82	137.20	342.94	160.52	144.05	613.17	647.46	382.72	325.14
3 1/2" (89 mm)	60.40	160.52	87.82	137.20	342.94	160.52	144.05	613.17	647.46	382.72	325.14
4" (102 mm)	-	-	-	-	-	-	256.53	Style 8940 - 613.17 Style 8840 - 644.71	762.95	-	-

List Price - US Dollars

†Includes one Universal Joint Kit. Additional Kits (P/N 109322) ★\$390.00

**Rigid NPT Male Adapters**

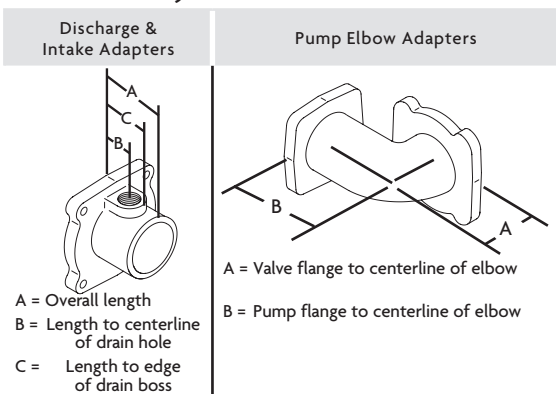

Style	Size							
	1" (25 mm)	1 1/2" (38 mm)	2" (51 mm)	2 1/2" (65 mm)	3" (75 mm)	3 1/2" (89 mm)	4" (102 mm)	
	A	1 23/32" (42 mm)	1 5/16" (33 mm)	1 5/8" (41 mm)	2" (51 mm)	2 1/16" (52 mm)	2 7/32" (56 mm)	2 21/32" (75 mm)
	B	-	-	-	-	-	-	-
	C	-	-	-	-	-	-	-
	List Price - US Dollars	68.61	63.12	74.09	87.82	134.45	148.16	238.70
	A	-	-	-	3 7/16" (87 mm)	3 9/16" (90 mm)	-	-
	B	-	-	-	1 3/8" (35 mm)	1 3/8" (35 mm)	-	-
	TH'D	-	-	-	2 1/8" (54 mm)	2 1/8" (54 mm)	-	-
	List Price - US Dollars	-	-	-	134.44	193.43	-	-
	A	-	-	-	5" (127 mm)	5" (127 mm)	-	-
	B	-	-	-	1 3/8" (35 mm)	1 3/8" (35 mm)	-	-
	TH'D	-	-	-	2 1/8" (54 mm)	2 1/8" (54 mm)	-	-
	List Price - US Dollars	-	-	-	150.91	283.98	-	-
	A	-	-	1 15/16" (49 mm)	-	3 3/4" (95 mm)	-	-
	B	-	-	-	-	-	-	-
	TH'D	-	-	2 1/2" NPT (65 mm)	-	4" NPT (102 mm)	-	-
	List Price - US Dollars	-	-	89.19	-	245.55	-	-
	A	-	-	-	-	-	7 7/16" (189 mm)	-
	B	-	-	-	-	-	1 3/8" (35 mm)	-
	TH'D	-	-	-	-	-	2 1/8" (54 mm)	-
	List Price - US Dollars	-	-	-	-	-	322.36	-
	A	-	-	-	-	-	10 3/16" (259 mm)	-
	B	-	-	-	-	-	1 3/8" (35 mm)	-
	C	-	-	-	-	-	2 1/8" (54 mm)	-
	List Price - US Dollars	-	-	-	-	-	389.82	-

**Valve Dimension Key**



KEY
* 1/4" (6.4 mm) and 3/4" (19 mm) NPT taps
** (2) 3/4" (19 mm) NPT taps
*** 3/4" (19 mm) NPT tap
† 30° Angle
†† 90° Angle
+ Eccentric flange face
++ Slotted valve flange
+++ 8 holes flange - Use 4
# 4 hole flanges with 4 3/8" (111 mm) BC - for spacing
◇ (3) 3/4" (19 mm) NPT Taps





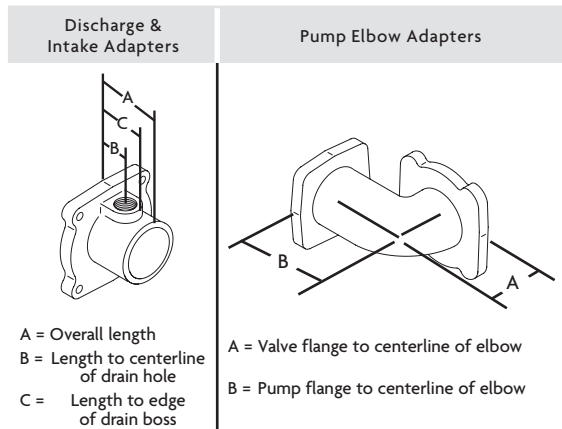









**Rigid NPT Female Adapters**

Style	Size							
	1" (25 mm)	1 1/2" (38 mm)	2" (51 mm)	2 1/2" (65 mm)	3" (75 mm)	3 1/2" (89 mm)	4" (102 mm)	
 P1-S	A	1 1/8" (29 mm)	1 1/8" (29 mm)	1 1/4" (32 mm)	1 7/8" (48 mm)	1 7/8" (48 mm)	2" (51 mm)	2 1/8" (54 mm)
	B	-	-	-	-	-	-	-
	C	-	-	-	-	-	-	-
	List Price - US Dollars	30.80	43.40	67.19	83.69	128.98	148.16	219.49
 *P2-S	A	-	3 3/8" (86 mm)	3 1/4" (83 mm)	3 19/32" (91 mm)	3 7/16" (87 mm)	4" (102 mm)	4 5/16" (110 mm)
	B	-	1 5/8" (41 mm)	1 3/8" (35 mm)	1 3/8" (35 mm)	1 3/8" (35 mm)	1 3/8" (35 mm)	1 13/16" (46 mm)
	C	-	1 3/8" (35 mm)	2 1/8" (54 mm)	2 1/8" (54 mm)	2 1/8" (54 mm)	2 1/8" (54 mm)	2 19/32" (66 mm)
	List Price - US Dollars	-	107.03	111.11	124.85	190.69	209.89	319.62
 *P2-SE	A	-	-	-	4 3/16" (106 mm)	-	-	-
	B	-	-	-	1 3/4" (44 mm)	-	-	-
	C	-	-	-	2 15/32" (63 mm)	-	-	-
	List Price - US Dollars	-	-	-	153.66	-	-	-
 P10-S	A	-	1 1/4" (32 mm)	2 1/32" (52 mm)	3 5/16" (84 mm)	-	-	-
	B	-	-	-	-	-	-	-
	TH'D	-	2" NPT (51 mm)	2 1/2" NPT (65 mm)	3" NPT (75 mm)	-	-	-
	List Price - US Dollars	-	67.24	105.65	111.11	-	-	-
 *P12-S	A	-	-	-	-	3 3/4" (95 mm)	3 3/4" (95 mm)	-
	B	-	-	-	-	1 3/8" (35 mm)	1 3/8" (35 mm)	-
	TH'D	-	-	-	-	4" NPT (102 mm)	4" NPT (102 mm)	-
	List Price - US Dollars	-	-	-	-	226.35	226.35	-
 P20-SF	A	-	-	3 5/32" (80 mm)	3 7/16" (87 mm)	4" (102 mm)	-	4" (102 mm)
	TH'D	-	-	2" NPT (51 mm) 2 1/2" VIC (65 mm)	2 1/2" NPT (65 mm) 3" VIC (75 mm)	3" NPT (75 mm)	-	4" NPT (102 mm)
	For Flow Meter							
	List Price - US Dollars	-	-	296.32	355.30	477.36	-	727.03
 *P30-SCV	A	-	5 5/8" (143 mm)	5 27/32" (148 mm)	6 1/4" (159 mm)	7 1/2" (191 mm)	-	-
	B	-	1 21/32" (42 mm)	3 7/8" (98 mm)	4 9/32" (109 mm)	4 15/16" (125 mm)	-	-
	TH'D	-	1 1/2" NPT (34 mm) 2" VIC (51 mm)	2" NPT (51 mm)	2 1/2" NPT (65 mm)	3" NPT (75 mm)	-	-
	Built-in Check Valve							
List Price - US Dollars	-	411.54	685.87	727.03	825.77	-	-	
 P40-SCV	A	-	-	-	-	6 1/16" (154 mm)	-	-
	3" NPT x 4" Victaulic (76 x 102 mm)							
	Built-in Check Valve							
	List Price - US Dollars	-	-	-	-	-	713.30	-

**Valve Dimension Key**

**KEY**

- \* 1/4" (6.4 mm) and 3/4" (19 mm) NPT taps
- \*\* (2) 3/4" (19 mm) NPT taps
- \*\*\* 3/4" (19 mm) NPT tap
- † 30° Angle
- †† 90° Angle
- + Eccentric flange face
- ++ Slotted valve flange
- +++ 8 holes flange - Use 4
- # 4 hole flanges with 4 3/8" (111 mm) BC - for spacing
- ◇ (3) 3/4" (19 mm) NPT Taps









**Male Discharge Adapters (Hose Thread)**

Style	Size							
	1" (25 mm)	1 1/2" (38 mm)	2" (51 mm)	2 1/2" (65 mm)	3" (75 mm)	3 1/2" (89 mm)	4" (102 mm)	
 M1-S	A	1 1/16" (43 mm)	1 5/16" (33 mm)	1 5/8" (41 mm)	2" (51 mm)	2 7/8" (73 mm)	2 7/8" (73 mm)	2 21/32" (67 mm)
	B	-	-	-	-	-	-	-
	C	-	-	-	-	-	-	-
	List Price - US Dollars	68.61	63.12	74.09	87.82	134.45	148.16	238.70
 M2-S	A	-	-	1 15/16" (49 mm)	-	-	-	-
	B	-	-	-	-	-	-	-
	THD	-	-	2 1/2" NH (65 mm)	-	-	-	-
	List Price - US Dollars	-	-	85.06	-	-	-	-
 *M3-S	A	-	-	-	3 3/16" (81 mm)	3 5/16" (84 mm)	-	3 19/32" (91 mm)
	B	-	-	-	1 3/8" (35 mm)	1 3/8" (35 mm)	-	1 13/16" (46 mm)
	C	-	-	-	2 1/8" (54 mm)	2 1/8" (54 mm)	-	2 5/8" (67 mm)
	List Price - US Dollars	-	-	-	134.44	193.43	-	315.51
 *M4-S	A	-	-	-	5" (127 mm)	5" (127 mm)	4 15/16" (124 mm)	8 3/4" (222 mm)
	B	-	-	-	1 3/8" (35 mm)	1 3/8" (35 mm)	1 7/8" (35 mm)	1 13/16" (46 mm)
	C	-	-	-	2 1/8" (54 mm)	2 1/8" (54 mm)	2 1/8" (54 mm)	2 15/32" (63 mm)
	List Price - US Dollars	-	-	-	150.91	283.98	309.73	480.11
 *M6-S	A	-	-	-	10" (254 mm)	-	-	-
	B	-	-	-	1 3/8" (35 mm)	-	-	-
	C	-	-	-	2 1/8" (54 mm)	-	-	-
	List Price - US Dollars	-	-	-	279.85	-	-	-
 *M7-S	A	-	-	-	6 1/2" (165 mm)	-	-	-
	B	-	-	-	1 3/8" (35 mm)	-	-	-
	C	-	-	-	2 1/8" (54 mm)	-	-	-
	List Price - US Dollars	-	-	-	307.28	-	-	-
 *M8-S	A	-	-	2 7/8" (73 mm)	-	-	-	-
	C	-	-	1 17/64" (32 mm)	-	-	-	-
	THD	-	-	1 1/2" NH (38 mm)	-	-	-	-
	List Price - US Dollars	-	-	142.76	-	-	-	-
 *M10-S	A	-	-	3 7/32" (82 mm)	-	-	-	-
	B	-	-	1 25/64" (35 mm)	-	-	-	-
	THD	-	-	2 1/2" NH (65 mm)	-	-	-	-
	List Price - US Dollars	-	-	124.85	-	-	-	-
 *† ME1-S	A	-	-	-	6 3/8" (168 mm)	7" (178 mm)	7 3/16" (183 mm)	9 3/4" (248 mm)
	B	-	-	-	1 3/8" (35 mm)	1 3/8" (35 mm)	1 3/8" (35 mm)	1 5/8" (41 mm)
	C	-	-	-	2 1/8" (54 mm)	2 1/8" (54 mm)	2 1/8" (54 mm)	2 5/16" (59 mm)
	List Price - US Dollars	-	-	-	248.28	289.45	322.36	548.71
 **† ME2-S	A	-	-	-	-	-	5 1/8" (130 mm)	-
	B	-	-	-	-	-	1 3/8" (35 mm)	-
	C	-	-	-	-	-	2 1/8" (54 mm)	-
	List Price - US Dollars	-	-	-	-	-	371.74	-
 *† ME3-S	A	-	-	-	10 5/16" (278 mm)	10 3/8" (265 mm)	10 3/16" (259 mm)	-
	B	-	-	-	1 3/8" (35 mm)	1 3/8" (35 mm)	1 3/8" (35 mm)	-
	C	-	-	-	2 1/8" (54 mm)	2 1/8" (54 mm)	2 1/8" (54 mm)	-
	List Price - US Dollars	-	-	-	279.85	304.55	396.46	-
 *† ME4-S	A	-	-	-	12 5/16" (313 mm)	-	-	-
	B	-	-	-	1 3/8" (35 mm)	-	-	-
	C	-	-	-	2 1/8" (54 mm)	-	-	-
	List Price - US Dollars	-	-	-	370.40	-	-	-
 *† ME5-S 2 1/2" Thread	A	-	-	-	-	6 7/8" (175 mm)	-	-
	B	-	-	-	-	1 3/8" (35 mm)	-	-
	C	-	-	-	-	2 1/8" (54 mm)	-	-
	List Price - US Dollars	-	-	-	-	325.15	-	-
 †† MES1-S	A	-	3 7/32" (82 mm)	3 3/8" (86 mm)	5 3/8" (132 mm)	-	-	-
	B	-	-	-	-	-	-	-
	C	-	-	-	-	-	-	-
	List Price - US Dollars	-	233.22	253.77	466.40	-	-	-

KEY	
*	3/4" (6.4 mm) and 3/4" (19 mm) NPT taps
**	(2) 3/4" (19 mm) NPT taps
***	3/4" (19 mm) NPT tap
†	30° Angle
††	90° Angle
+	Eccentric flange face
++	Slotted valve flange
+++	8 holes flange - Use 4
#	4 hole flanges with 4 3/8" (111 mm) BC - for spacing
◇	(3) 3/4" (19 mm) NPT Taps

**List Price Guide**  
 Effective: January 5, 2015  
 Akron Brass Company | PH. 800.228.1161 (330.264.5678) | FAX 800.531.7335 (330.264.2944) | www.akronbrass.com

**Female Intake Adapters Chrome Swivels (Hose Thread)**

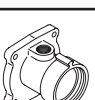
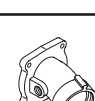

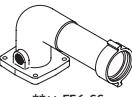

Style	Size						
	1 1/2" (38 mm)	2" (51 mm)	2 1/2" (65 mm)	3" (75 mm)	3 1/2" (89 mm)	4" (102 mm)	
 FI-S	A	1 3/4" (44 mm)	-	2 1/16" (75 mm)	2 1/16" (75 mm)	2 5/8" (67 mm)	3 5/8" (92 mm)
	B	-	-	-	-	-	-
	C	-	-	-	-	-	-
	List Price - US Dollars	131.71	-	178.36	224.99	279.85	377.24
 *F2-S	A	-	-	3 1/2" (89 mm)	3 3/4" (95 mm)	4 1/2" (114 mm)	5 1/2" (140 mm)
	B	-	-	1 3/8" (35 mm)	1 3/8" (35 mm)	1 3/8" (35 mm)	1 13/16" (46 mm)
	C	-	-	2 1/8" (54 mm)	2 1/8" (54 mm)	2 1/8" (54 mm)	2 17/32" (65 mm)
	List Price - US Dollars	-	-	207.14	270.26	356.65	459.55
 *F3-S	A	-	-	5 1/2" (140 mm)	5 1/2" (140 mm)	5 1/2" (140 mm)	-
	B	-	-	1 3/8" (35 mm)	1 3/8" (35 mm)	1 3/8" (35 mm)	-
	C	-	-	2 1/8" (54 mm)	2 1/8" (54 mm)	2 1/8" (54 mm)	-
	List Price - US Dollars	-	-	227.72	285.34	375.88	-
 FI-SS	A	1 3/4" (44 mm)	-	2 1/16" (75 mm)	2 1/16" (75 mm)	2 5/8" (67 mm)	3 5/8" (92 mm)
	B	-	-	-	-	-	-
	C	-	-	-	-	-	-
	List Price - US Dollars	142.14	-	185.21	234.58	297.67	397.82
 *F2-SS	A	-	-	3 1/2" (89 mm)	3 3/4" (95 mm)	4 1/2" (114 mm)	5 1/2" (140 mm)
	B	-	-	1 3/8" (35 mm)	1 3/8" (35 mm)	1 3/8" (35 mm)	1 13/16" (46 mm)
	C	-	-	2 1/8" (54 mm)	2 1/8" (54 mm)	2 1/8" (54 mm)	2 17/32" (65 mm)
	List Price - US Dollars	-	-	216.74	279.85	374.50	480.11
 *F3-SS	A	-	-	5 1/2" (140 mm)	5 1/2" (140 mm)	5 1/2" (140 mm)	-
	B	-	-	1 3/8" (35 mm)	1 3/8" (35 mm)	1 3/8" (35 mm)	-
	C	-	-	2 1/8" (54 mm)	2 1/8" (54 mm)	2 1/8" (54 mm)	-
	List Price - US Dollars	-	-	238.70	294.93	393.69	-
 *F4-SS 2 1/2" swivel	A	-	-	-	3 13/16" (97 mm)	-	-
	B	-	-	-	1 3/8" (35 mm)	-	-
	C	-	-	-	2 1/8" (54 mm)	-	-
	List Price - US Dollars	-	-	-	289.45	-	-
 *F5-SS 2 1/2" swivel	A	-	-	-	5 1/2" (140 mm)	-	-
	B	-	-	-	1 3/8" (35 mm)	-	-
	C	-	-	-	2 1/8" (54 mm)	-	-
	List Price - US Dollars	-	-	-	353.91	-	-
 ***F6-SS 4" swivel	A	-	-	-	4" (102 mm)	-	-
	B	-	-	-	1 3/8" (35 mm)	-	-
	C	-	-	-	2 3/32" (53 mm)	-	-
	List Price - US Dollars	-	-	-	694.10	-	-
 ***F12-SS	A	-	4 5/8" (117 mm)	-	-	-	-
	B	-	1 25/64" (35 mm)	-	-	-	-
	THD	-	2 1/2" NH (65 mm)	-	-	-	-
	List Price - US Dollars	-	216.74	-	-	-	-
 ***F1 FE2-SS	A	-	-	-	-	6 3/4" (171 mm)	-
	B	-	-	-	-	1 3/8" (35 mm)	-
	C	-	-	-	-	2 1/8" (54 mm)	-
	List Price - US Dollars	-	-	-	-	484.22	-

KEY
* 1/4" (6.4 mm) and 3/4" (19 mm) NPT taps
** (2) 3/4" (19 mm) NPT taps
*** 3/4" (19 mm) NPT tap
† 30° Angle
†† 90° Angle
+ Eccentric flange face
++ Slotted valve flange
+++ 8 holes flange - Use 4
# 4 hole flanges with 4 3/8" (111 mm) BC - for spacing
◇ (3) 3/4" (19 mm) NPT Taps

**Female Intake Adapters Chrome Swivels (Hose Thread) Continued...**

Style	Size						
	1 1/2" (38 mm)	2" (51 mm)	2 1/2" (65 mm)	3" (75 mm)	3 1/2" (89 mm)	4" (102 mm)	
 *† FE3-SS	A	-	-	7 7/8" (181 mm)	7 3/4" (197 mm)	7 7/8" (200 mm)	-
	B	-	-	1 3/8" (35 mm)	1 3/8" (35 mm)	1 3/8" (35 mm)	-
	C	-	-	2 1/8" (54 mm)	2 1/8" (54 mm)	2 1/8" (54 mm)	-
	List Price - US Dollars	-	-	348.44	423.88	476.00	-
 ***†† FE6-SS	A	-	-	10 3/4" (273 mm)	-	-	-
	B	-	-	1 3/8" (35 mm)	-	-	-
	C	-	-	2 1/4" (57 mm)	-	-	-
	List Price - US Dollars	-	-	493.84	-	-	-

**Flex Hose & Solder Adapters**

Style	Size						
	1" (25 mm)	1 1/2" (38 mm)	2" (51 mm)	2 1/2" (65 mm)	3" (75 mm)	3 1/2" (89 mm)	4" (102 mm)
 PI-SH	A	-	-	-	1 7/8" (48 mm)	1 15/16" (49 mm)	2 5/16" (59 mm)
	B	-	-	-	-	-	-
	C	-	-	-	-	-	-
	List Price - US Dollars	-	-	-	97.42	119.35	-
 PI2-SH	A	-	-	-	1 15/16" (49 mm)	-	-
	List Price - US Dollars	-	-	-	-	329.23	-
 PA-SH	A	-	-	-	-	2 1/4" (57 mm)	-
	B	-	-	-	-	-	-
	Angle	-	-	-	-	4" (102 mm)	-
	List Price - US Dollars	-	-	-	-	148.16	-
 PO-SH	A	-	-	-	-	2 1/4" (57 mm)	-
	B	-	-	-	-	-	-
	Angle	-	-	-	-	4" (102 mm)	-
	List Price - US Dollars	-	-	-	-	148.16	-
 P3-S	A	1 1/8" (29 mm)	1 3/32" (26 mm)	1 1/4" (32 mm)	1 7/8" (48 mm)	1 7/8" (48 mm)	-
	B	-	-	-	-	-	-
	C	-	-	-	-	-	-
	List Price - US Dollars	60.40	63.12	80.97	87.82	137.20	-

Flex

Solder





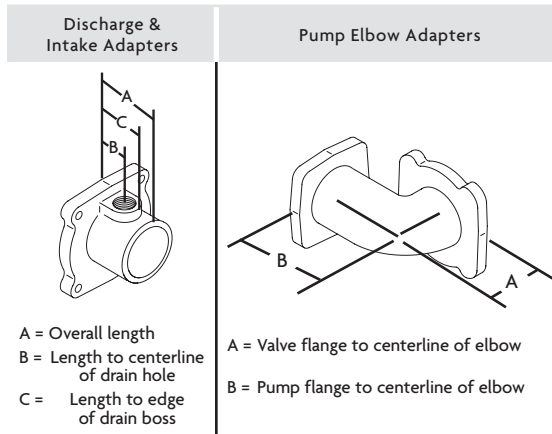



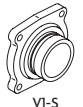

KEY	
*	1/4" (6.4 mm) and 3/4" (19 mm) NPT taps
**	(2) 3/4" (19 mm) NPT taps
***	3/4" (19 mm) NPT tap
†	30° Angle
††	90° Angle
+	Eccentric flange face
++	Slotted valve flange
+++	8 holes flange - Use 4
#	4 hole flanges with 4 3/8" (113 mm) BC - for spacing
◇	(3) 3/4" (19 mm) NPT Taps

**Valve Dimension Key**





**Victaulic Adapters**









Style	Size								
	1" (25 mm)	1 1/2" (38 mm)	2" (51 mm)	2 1/2" (65 mm)	3" (75 mm)	3 1/2" (89 mm)	4" (102 mm)		
 VI-S	A	1 11/16" (43 mm)	1 3/4" (44 mm)	1 29/32" (48 mm)	1 29/32" (48 mm)	2 3/32" (53 mm)	2 5/32" (53 mm)	2 1/4" (57 mm)	
	B	-	-	-	-	-	-	-	
	C	-	-	-	-	-	-	-	
	List Price - US Dollars	37.05	50.77	65.87	91.93	167.38	196.18	285.34	
 *V3-S	A	-	3 5/16" (84 mm)	3 1/4" (83 mm)	3 3/16" (81 mm)	3 5/16" (84 mm)	-	4" (102 mm)	
	B	-	1 3/8" (35 mm)	1 3/8" (35 mm)	1 3/8" (35 mm)	1 3/8" (35 mm)	-	1 15/16" (49 mm)	
	C	-	-	-	-	-	-	-	
	List Price - US Dollars	-	105.65	111.11	178.36	253.77	-	309.44	
 *V4-S	A	-	-	-	3 1/2" (89 mm)	-	-	-	
	B	-	-	-	1 3/8" (35 mm)	-	-	-	
	C	-	-	-	2 1/8" (54 mm)	-	-	-	
	List Price - US Dollars	-	-	-	308.65	-	-	-	
2 1/2" (65 mm) with 3" (75 mm) Victaulic									
 *V5-S	A	-	-	3 1/2" (89 mm)	-	-	-	-	
	B	-	-	1 3/8" (35 mm)	-	-	-	-	
	C	-	-	2 1/8" (54 mm)	-	-	-	-	
	List Price - US Dollars	-	-	124.87	-	-	-	-	
2" (52 mm) with 1 1/2" (38 mm) Victaulic									
 VT-S	A	-	-	-	-	2 5/32" (52 mm)	-	2 11/32" (60 mm)	
	3" (75 mm) has 3" (75 mm) NPT + 4" (102 mm) Victaulic								
	4" (102 mm) has 4" (102 mm) NPT + 5" (127 mm) Victaulic								
	List Price - US Dollars	-	-	-	-	253.77	-	278.48	
 *VT3-S	A	-	-	-	-	3 7/16" (87 mm)	-	-	
	B	-	-	-	-	1 3/8" (35 mm)	-	-	
	C	-	-	-	-	2 1/8" (54 mm)	-	-	
	List Price - US Dollars	-	-	-	-	397.82	-	-	
3" (75 mm) NPT with 4" (102 mm) Victaulic									
 †† VE1-S *** 1 1/2"	A	-	3 5/8" (92 mm)	3 3/4" (95 mm)	-	-	-	-	
	B	-	3" (75 mm)	3" (75 mm)	-	-	-	-	
	C	-	-	-	-	-	-	-	
	List Price - US Dollars	-	170.11	219.49	-	-	-	-	
 *†† VE2-S	A	-	-	5 3/4" (146 mm)	-	-	-	-	
	B	-	-	2 31/32" (75 mm)	-	-	-	-	
	C	-	-	-	-	-	-	-	
	List Price - US Dollars	-	-	229.09	-	-	-	-	
 V20-SF For Flow Meter	A	-	-	3 3/16" (81 mm)	3 3/16" (81 mm)	4 1/4" (108 mm)	-	-	
	B	-	-	1 1/4" (32 mm)	1 1/4" (32 mm)	1 5/8" (41 mm)	-	-	
	TH'D	-	-	2" VIC (51 mm)	2" VIC (51 mm)	3" VIC (75 mm)	-	-	
	List Price - US Dollars	-	-	296.32	355.30	477.36	-	-	
 † V30-SCV	A	-	-	5 27/32" (148 mm)	6 1/4" (159 mm)	7 1/2" (191 mm)	-	-	
	B	-	-	3 7/8" (98 mm)	4 9/32" (109 mm)	4 15/16" (125 mm)	-	-	
	Built-in Check Valve								
	List Price - US Dollars	-	-	685.87	727.67	825.77	-	-	
 †† VES1-S	A	-	-	3 3/8" (86 mm)	5 3/16" (132 mm)	-	-	-	
	B	-	-	-	-	-	-	-	
	C	-	-	-	-	-	-	-	
	List Price - US Dollars	-	-	253.57	466.40	-	-	-	

Victaulic

**Pump Flange Adapters (Hale Pump Use)**

Style	Size						
	2 1/2" (65 mm)	3/3 1/2" (75/89 mm)	4" (102 mm)	Angle	Bolt Holes	Bolt CIR. DIA.	
B1-SE	A	-	2 7/8" (73 mm)	-	-	8	5 3/4" (146 mm)
	B	-	-	-	-	-	-
	C	-	-	-	-	-	-
	List Price - US Dollars	-	181.10	-	-	-	-
+ B2-SE	A	-	2 7/8" (73 mm)	-	26°	8	5 3/4" (146 mm)
	B	-	-	-	-	-	-
	C	-	-	-	-	-	-
	List Price - US Dollars	-	264.76	-	-	-	-
B3-SE	A	-	3 1/8" (79 mm)	4" (102 mm)	3°30'	8	5 3/4" (146 mm)
	B	-	-	-	-	-	-
	C	-	-	-	-	-	-
	List Price - US Dollars	-	274.37	320.01	-	-	-
B6-SE	A	-	6 7/8" (175 mm)	-	4°	8	5 3/4" (146 mm)
	B	-	-	-	-	-	-
	C	-	-	-	-	-	-
	List Price - US Dollars	-	329.23	-	-	-	-
B8-SH (Octagonal Flange)	A	-	-	4" (102 mm)	-	8	5 3/4" (146 mm)
	B	-	-	-	-	-	-
	C	-	-	-	-	-	-
	List Price - US Dollars	-	-	325.14	-	-	-
B20-SFH	A	-	-	5 27/64" (138 mm)	-	8	5 3/4" (146 mm)
	B	-	-	2 43/64" (68 mm)	-	-	-
	For Flow Meter						
	List Price - US Dollars	-	-	823.05	-	-	-
HDE1-S	A	-	4 9/16" (116 mm)	9 1/2" (241 mm)	90°	8	5 3/4" (146 mm)
	B	-	4 5/16" (110 mm)	5" (127 mm)	-	-	-
	C	-	-	-	-	-	-
	List Price - US Dollars	-	251.03	528.13	-	-	-
HDE2-S	A	-	4 9/16" (116 mm)	-	90°	8	5 3/4" (146 mm)
	B	-	4 5/16" (110 mm)	-	-	-	-
	Pump flange bolt holes on crosshairs						
	List Price - US Dollars	-	251.03	-	-	-	-
HDE94-S	A	-	-	9 1/2" (241 mm)	94°	8	5 3/4" (146 mm)
	B	-	-	5" (127 mm)	-	-	-
	C	-	-	-	-	-	-
	List Price - US Dollars	-	-	351.17	-	-	-
++ HD1-S	A	6 1/4" (159 mm)	5 3/4" (146 mm)	-	2 1/2"-5° 20' 3"-7°	4	4 3/8" (111 mm)
	B	-	-	-	-	-	-
	Angle	5°20'	7°	-	-	-	-
	List Price - US Dollars	216.74	224.99	-	-	-	-
++ HD2-S	A	8 1/4" (210 mm)	7 3/4" (197 mm)	-	2 1/2"-3° 45' 3"-4°	4	4 3/8" (111 mm)
	B	-	-	-	-	-	-
	List Price - US Dollars	224.99	238.70	-	-	-	-
	C	-	-	-	-	-	-
++ HD3-S	A	6 5/8" (168 mm)	-	-	5°20'	4	4 3/8" (111 mm)
	B	-	-	-	-	-	-
	C	-	-	-	-	-	-
	List Price - US Dollars	227.72	-	-	-	-	-
HD4-S	A	5 1/4" (133 mm)	-	-	14°5'	4	4 3/8" (111 mm)
	B	-	-	-	-	-	-
	C	-	-	-	-	-	-
	List Price - US Dollars	209.89	-	-	-	-	-

KEY	
*	1/4" (6.4 mm) and 3/8" (19 mm) NPT taps
**	(2) 3/4" (19 mm) NPT taps
***	3/4" (19 mm) NPT tap
†	30° Angle
††	90° Angle
+	Eccentric flange face
++	Slotted valve flange
+++	8 holes flange - Use 4
#	4 hole flanges with 4 3/8" (111 mm) BC - for spacing
◇	(3) 3/4" (19 mm) NPT Taps

Style	Size						
	2 1/2" (65 mm)	3 3/4" (75/89 mm)	4" (102 mm)	Angle	Bolt Holes	Bolt CIR. DIA.	
 ++ HD5-S	A	10 1/4" (260 mm)	-	-	4°	4	4 3/8" (111 mm)
	B	-	-	-	-	-	-
	C	-	-	-	-	-	-
	List Price - US Dollars	237.33	-	-	-	-	-
 ++ HD6-S	A	7 1/4" (184 mm)	-	-	14°50'	8	4 3/8" (111 mm)
	B	-	-	-	-	-	-
	C	-	-	-	-	-	-
	List Price - US Dollars	249.20	-	-	-	-	-
 ++ HD7-S	A	7 1/4" (184 mm)	-	-	5°20'	4	4 3/8" (111 mm)
	B	-	-	-	-	-	-
	C	-	-	-	-	-	-
	List Price - US Dollars	249.20	-	-	-	-	-
 ++ HD21-SF UP or DN For Flow Meter	A	6 1/4" (159 mm)	-	-	-	4	4 3/8" (111 mm)
	B	3 1/8" (79 mm)	-	-	-	-	-
	Angle	5°20'	-	-	-	-	-
	List Price - US Dollars	548.71	-	-	-	-	-
 ++ SE1-S	A	3 1/4" (83 mm)	2 3/4" (70 mm)	-	90°	4	4 3/8" (111 mm)
	B	5 1/4" (133 mm)	6" (153 mm)	-	-	-	-
	C	-	-	-	-	-	-
	List Price - US Dollars	241.45	251.03	-	-	-	-
 ++ SE2-S	A	5 1/4" (133 mm)	4 3/4" (121 mm)	-	90°	4	4 3/8" (111 mm)
	B	5 1/4" (133 mm)	6" (153 mm)	-	-	-	-
	C	-	-	-	-	-	-
	List Price - US Dollars	253.77	292.20	-	-	-	-
 ++ SE3-S	A	2 1/2" (65 mm)	-	-	90°	4	4 3/8" (111 mm)
	B	7 3/4" (197 mm)	-	-	-	-	-
	C	-	-	-	-	-	-
	List Price - US Dollars	253.77	-	-	-	-	-
 ++ SE4-S	A	6" (153 mm)	-	-	90°	4	4 3/8" (111 mm)
	B	8 1/2" (140 mm)	-	-	-	-	-
	C	-	-	-	-	-	-
	List Price - US Dollars	262.85	-	-	-	-	-
 DE3-S	A	-	4 15/16" (125 mm)	4 15/16" (125 mm)	94°	8	5 3/4" (146 mm)
	B	-	5 3/16" (132 mm)	5" (127 mm)	-	-	-
	C	-	-	-	-	-	-
	List Price - US Dollars	-	237.33	352.57	-	-	-

- \* 1/4" (6.4 mm) and 3/4" (19 mm) NPT taps
- \*\* (2) 3/4" (19 mm) NPT taps
- \*\*\* 3/4" (19 mm) NPT tap
- † 30° Angle
- †† 90° Angle
- + Eccentric flange face
- ++ Slotted valve flange
- +++ 8 holes flange - Use 4
- # 4 hole flanges with 4 3/8" (111 mm) BC - for spacing
- ◇ (3) 3/4" (19 mm) NPT Taps

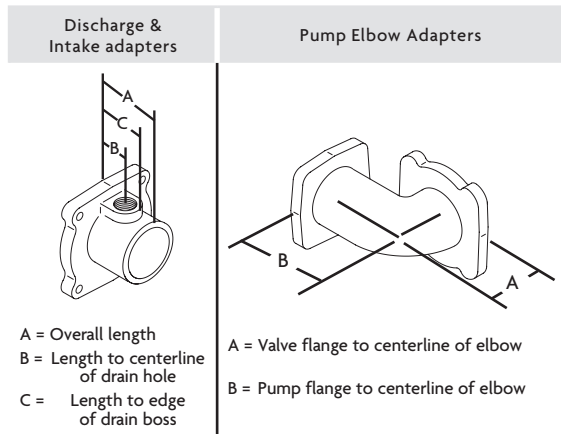

**Pump Flange Adapters (Waterous Pump Use)**

Style	Size						
	2" (51 mm)	2 1/2" (65 mm)	3/3 1/2" (75/89 mm)	4" (102 mm)	Angle	Bolt Hole	Bolt CIR. DIA.
B1-S	A	2 5/8" (67 mm)	2 5/8" (67 mm)	2 7/8" (73 mm)	-	-	4 (8 on 2") 4 3/8" (111 mm)
	B	-	-	-	-	-	-
	C	-	-	-	-	-	-
	List Price - US Dollars	134.45	150.91	167.38	-	-	-
B1-SX	A	-	2 5/8" (67 mm)	-	-	4 slots	4 3/8" (111 mm)
	B	-	-	-	-	-	-
	C	-	-	-	-	-	-
	List Price - US Dollars	-	148.16	-	-	-	-
B3-S Both flanges 4 3/8" B CD	A	-	2 5/8" (67 mm)	-	-	4	4 3/8" (111 mm)
	B	-	-	-	-	-	-
	C	-	-	-	-	-	-
	List Price - US Dollars	-	150.91	-	-	-	-
B4-S	A	-	2 5/8" (67 mm)	2 7/8" (73 mm)	-	8	4 3/8" (111 mm)
	B	-	-	-	-	-	-
	C	-	-	-	-	-	-
	List Price - US Dollars	-	120.73	145.43	-	-	-
B5-S	A	-	4 5/8" (114 mm)	-	-	-	4 3/8" (111 mm)
	A	-	-	4 1/2" (114 mm)	-	4 slots + 4 holes	4 3/8" (111 mm)
	B	-	-	-	-	-	-
	List Price - US Dollars	-	171.50	190.69	-	-	-
B6-S	A	-	6" (153 mm)	-	-	8	4 3/8" (111 mm)
	B	-	-	-	-	-	-
	C	-	-	-	-	-	-
	List Price - US Dollars	-	196.18	-	-	-	-
B7-S	A	-	5" (127 mm)	-	-	8	4 3/8" (111 mm)
	B	-	-	-	-	-	-
	C	-	-	-	-	-	-
	List Price - US Dollars	-	190.29	-	-	-	-
B1-SH	A	-	5/8"-1 1/8" (16-29 mm)	1 1/10"-1 3/16" (28-30 mm)	-	4°	8 6 5/8" (168 mm)
	B	-	-	-	-	-	-
	C	-	-	-	-	-	-
	List Price - US Dollars	-	248.28	251.03	-	-	-
B1-SH (4")	A	-	-	-	2" Total (51 mm)	4°	8 6 5/8" (168 mm)
	B	-	-	-	-	-	-
	C	-	-	-	-	-	-
	List Price - US Dollars	-	-	-	748.85	-	-
B2-SH	A	-	1 1/16" (17 mm)	-	-	4	4 3/8" (111 mm)
	B	-	-	-	-	-	-
	C	-	-	-	-	-	-
	List Price - US Dollars	-	192.07	-	-	-	-
B3-SH	A	-	-	1 3/16"-1 11/32" (2.1-34 mm)	-	4°	4 7 25/32" (198 mm)
	B	-	-	-	-	-	-
	C	-	-	-	-	-	-
	List Price - US Dollars	-	-	274.37	-	-	-
B3-SH (4")	A	-	-	-	2" Total (51 mm)	4°	4 7 25/32" (198 mm)
	B	-	-	-	-	-	-
	C	-	-	-	-	-	-
	List Price - US Dollars	-	-	-	748.85	-	-
B1-SW Clamps	A	-	1 27/32" (47 mm)	1 27/32" (47 mm)	-	4	4 3/8" (111 mm)
	B	-	-	-	-	-	-
	C	-	-	-	-	-	-
	List Price - US Dollars	-	274.37	289.45	-	-	-
B2-SW	A	-	-	2 7/8" (73 mm)	-	26°	8 5 1/2" (140 mm)
	B	-	-	-	-	-	-
	C	-	-	-	-	-	-
	List Price - US Dollars	-	-	263.39	-	-	-

KEY	
*	1/4" (6.4 mm) and 3/4" (19 mm) NPT taps
**	(2) 3/4" (19 mm) NPT taps
***	3/4" (19 mm) NPT tap
↑	30° Angle
↑↑	90° Angle
+	Eccentric flange face
++	Slotted valve flange
+++	8 holes flange - Use 4
#	4 hole flanges with 4 3/8" (111 mm) BC - for spacing
◇	(3) 3/4" (19 mm) NPT Taps

**Pump Flange Adapters (Waterous Pump Use) Continued**

Style	Size							
	2" (51 mm)	2 1/2" (65 mm)	3/3 1/2" (75/89 mm)	4" (102 mm)	Angle	Bolt Hole	Bolt CIR. DIA.	
B3-SW	A	-	-	3 1/8" (79 mm)	-	4°	8	5 1/2" (140 mm)
	B	-	-	-	-	-	-	-
	C	-	-	-	-	-	-	-
	List Price - US Dollars	-	-	274.37	-	-	-	-
B4-SW	A	-	-	5" (127 mm)	-	4°	8	5 1/2" (140 mm)
	B	-	-	-	-	-	-	-
	C	-	-	-	-	-	-	-
	List Price - US Dollars	-	-	282.59	-	-	-	-
B8-SW	A	-	-	-	4" (102 mm)	-	8	5 1/2" (140 mm)
	B	-	-	-	-	-	-	-
	C	-	-	-	-	-	-	-
	List Price - US Dollars	-	-	-	325.14	-	-	-
B10-SF	A	-	-	2 7/8" (73 mm)	-	-	8	5 1/2" (140 mm)
	List Price - US Dollars	-	-	181.10	-	-	-	-
B20-SFW	A	-	3 1/2" (89 mm)	3 9/32" (83 mm)	-	-	4	4 3/8" (111 mm)
	B	-	1 5/64" (46 mm)	1 3/8" (35 mm)	-	-	-	-
	For Flow Meter							
	List Price - US Dollars	-	363.54	363.54	-	-	-	-
WDEI-S	A	-	-	-	5 27/64" (138 mm)	-	8	5 1/2" (140 mm)
	B	-	-	-	2 43/64" (68 mm)	-	-	-
	For Flow Meter							
	List Price - US Dollars	-	-	-	823.05	-	-	-
WDE94-S	A	-	-	4 9/16" (112 mm)	9 1/2" (241 mm)	90°	8	5 1/2" (140 mm)
	B	-	-	4 5/16" (110 mm)	5" (127 mm)	-	-	-
	C	-	-	-	-	-	-	-
	List Price - US Dollars	-	-	251.03	528.13	-	-	-
B10-SP	A	-	-	-	9 1/2" (241 mm)	94°	8	5 1/2" (140 mm)
	B	-	-	-	5" (127 mm)	-	-	-
	C	-	-	-	-	-	-	-
	List Price - US Dollars	-	-	-	351.17	-	-	-

**Pump Flange Adapters General Use**



Style	Size						
	2" (51 mm)	3" / 3 1/2" (75/89 mm)	4" (102 mm)	Angle	Bolt Hole	Bolt CIR. DIA.	
B10-SP	A	-	-	2" (51 mm)	-	4	7 1/16" (179 mm)
	B	-	-	-	-	-	-
	C	-	-	-	-	-	-
	List Price - US Dollars	-	-	329.23	-	-	-
DEI-S	A	3 3/4" (95 mm)	-	9 1/2" (241 mm)	90°	8	4 3/8" (111 mm)
	B	4 13/16" (122 mm)	-	5" (127 mm)	-	-	-
	C	-	-	-	-	-	-
	List Price - US Dollars	246.36	-	336.08	-	-	-
DE2-S	A	3 3/4" (95 mm)	-	-	90°	8	4 3/8" (111 mm)
	B	5 1/2" (140 mm)	-	-	-	-	-
	C	-	-	-	-	-	-
	List Price - US Dollars	281.22	-	-	-	-	-

KEY
* 1/4" (6.4 mm) and 3/4" (19 mm) NPT taps
** (2) 1/4" (19 mm) NPT taps
*** 3/4" (19 mm) NPT tap
† 30° Angle
†† 90° Angle
+ Eccentric flange face
++ Slotted valve flange
+++ 8 holes flange - Use 4
# 4 hole flanges with 4 3/8" (111 mm) BC - for spacing
◇ (3) 3/4" (19 mm) NPT Taps

Effective: January 5, 2015

Akron Brass Company | PH. 800.228.1161 (330.264.5678) | FAX 800.531.7335 (330.264.2944) | www.akronbrass.com

### Pump Flange Adapters (Darley Pump Use)

Style	Size					
	2 1/2 (65 mm)	3"/3 1/2 (75/89 mm)	4" (102 mm)	Angle	Bolt Hole	Bolt CIR. DIA.
 B2-S	A	2 5/8 (67 mm)	2 7/8 (73 mm)	-	-	4 4 19/32 (117 mm)
	B	-	-	-	-	-
	C	-	-	-	-	-
	List Price - US Dollars	175.59	185.21	-	-	-
 DD1-S	A	6 1/4 (159 mm)	5 3/4 (146 mm)	-	6°	4 4 19/32 (117 mm)
	B	-	-	-	-	-
	C	-	-	-	-	-
	List Price - US Dollars	237.33	264.76	-	-	-

### Butterfly Valves (List Price - US Dollars)

Style	Size	Length	Weight	Manual Handle With Adpts	Electric*		Handwheel		Air Actuator	
					With Adpts	Less Adpts	With Adpts	Less Adpts	With Adpts	Less Adpts
7940	4" (102 mm)	9 1/2" (241 mm)	21 1/4 (9.6 kg)	1,900.00	3,318.00	2,367.00	2,583.00	1,627.00	3,016.00	2,062.00
7945	4 1/2" (114 mm)	9 3/4" (248 mm)	27 1/4 (12.7 kg)	2,260.00	3,697.00	-	2,936.00	-	3,384.00	-
7950	5" (127 mm)	10" (254 mm)	28 1/2 (12.9 kg)	2,249.00	3,666.00	2,475.00	2,922.00	1,693.00	3,357.00	2,133.00
7960	6" (153 mm)	10" (254 mm)	35 1/2 (16.1 kg)	2,345.00	3,753.00	2,518.00	3,023.00	1,719.00	3,453.00	2,149.00

Add on (all sizes): 1/4" Bleeder - P/N 785027: \$12.00  
 3/4" Drain - P/N 0004-0001: \$202.00

#### Adapter Options:

Male, Female NPT, Female Swivel (rocker lug or long handle), Victaulic, Storz (swivel standard)

\*See Styles 9323 and 9325 for Electric Valve Control Option.

Note: For reducing or increasing sizes, use price for the largest size.

KEY
* 1/4" (6.4 mm) and 3/4" (19 mm) NPT taps
** (2) 3/4" (19 mm) NPT taps
*** 1/4" (19 mm) NPT tap
↑ 30° Angle
↑↑ 90° Angle
+ Eccentric flange face
++ Slotted valve flange
+++ 8 holes flange - Use 4
# 4 hole flanges with 4 3/8" (111 mm) BC - for spacing
◇ (3) 3/4" (19 mm) NPT Taps

### Valve Dimension Key

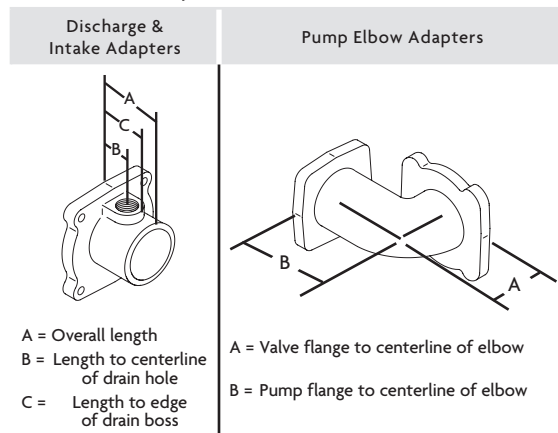

Style	Description	US\$ List Price
<b><u>Apparatus Flow Test Kits</u></b>		
<b>AFTK-25</b>	2 1/2" (65 mm) Flow Test Kit with Case and any Four (4) Tips.....	1,511.00
	<i>Tip Options:</i>	
	FK-301 1" (25 mm) Tip.....	106.00
	FK-302 1 1/4" (32 mm) Tip.....	106.00
	FK-303 1 1/2" (38 mm) Tip.....	106.00
	FK-304 1 3/4" (44 mm) Tip.....	106.00
	FK-305 2" (51 mm) Tip.....	106.00
	FK-306 2 1/4" (57 mm) Tip.....	106.00
	FK-307 2 1/2" (65 mm) Tip.....	106.00
	FK-330 3/4" (19 mm) Tip.....	106.00
	FK-332 1 1/8" (29 mm) Tip.....	106.00
<b>AFTK-30</b>	3" (75 mm) Flow Test Tip with Fixed 3" (75 mm) Tip, No Case.....	1,289.00
<b>AFTK-35</b>	3 1/2" (89 mm) Flow Test Tip with Fixed 3 1/2" (89 mm) Tip, No Case.....	1,402.00
<b>AFTK-40</b>	4" (102 mm) Flow Test Tip with Fixed 4" (102 mm) Tip, No Case.....	1,455.00
<b>AFTK-45</b>	4 1/2" (114 mm) Flow Test Tip with Fixed 4 1/2" (114 mm) Tip, No Case.....	1,486.00
<b>FK-230</b>	Case 18 3/8" x 14 1/4" x 8" (467 x 362 x 203 mm).....	192.00
<b>FK-231</b>	Case 20 3/4" x 16 1/2" x 9 1/4" (527 x 419 x 235 mm).....	293.00
<b>FK-232</b>	Case 19" x 13 3/8" x 7" (483 x 340 x 178 mm).....	138.00
<b>RG-230</b>	Remote Gauge Assembly for the FK, HK, and TGK-3 Flow Test Kit (includes 10' of tubing).....	113.00
<b>FK-105</b>	Additional tubing.....	★ 0.58 per foot
<b><u>Hydrant Flow Test Kits</u></b>		
<b>AHTK-25</b>	2 1/2" (65 mm) Hydrant Flow Test Kit with Case.....	1,229.00
<b>AHTK-25-NC2</b>	1/2" (65 mm) Hydrant Flow Test Kit, No Case.....	937.00
<b>AHTK-25-CG2</b>	1/2" (65 mm) Hydrant Flow Test Kit 2 1/2" (65 mm) including Cap Gauge with Case.....	1,555.00
<b>HKB-25</b>	2 1/2" (65 mm) Hydrant Flow Test Kit without Diffuser or Case.....	669.00
<b>HKD-25</b>	Diffuser for AHTK-25.....	347.00
<b>AHTK-40</b>	4" (102 mm) Hydrant Flow Test Kit with Diffuser.....	1,187.00
<b>AHTK-45</b>	4 1/2" (114 mm) Hydrant Flow Test Kit with Case.....	1,681.00
<b>AHTK-45-NC4</b>	1/2" (114 mm) Hydrant Flow Test Kit, No Case.....	1,404.00
<b>HKB-45</b>	4 1/2" (114 mm) Hydrant Flow Test Kit without Diffuser or Case.....	985.00
<b>FK-602</b>	45° Elbow for 2 1/2" (65 mm) barrel.....	347.00
<b>FK-604</b>	30° Elbow for 2 1/2" (65 mm) barrel.....	347.00
<b>FK-610</b>	30° Elbow for 4 1/2" (114 mm) MNST x 4 1/2" (114 mm) FNST.....	695.00
<b><u>Street Tee Diffuser</u></b>		
<b>STDR-25</b>	2 1/2" (65 mm) NST Street "T" Diffuser.....	341.00
<b>STDR-45</b>	4 1/2" (114 mm) NST Street "T" Diffuser.....	972.00
<b><u>Hand Held Pitot</u></b>		
<b>HHPT</b>	Hand Held Nozzle & Hydrant Pitot with Case.....	518.00
<b><u>Cap Gauges</u></b>		
<b>HCGK-15</b>	1 1/2" (34 mm) Cap Gauge.....	299.00
<b>HCGK-25</b>	2 1/2" (65 mm) Cap Gauge.....	328.00
<b>HCGK-30</b>	3" (75 mm) Cap Gauge.....	406.00
<b>HCGK-35</b>	3 1/2" (89 mm) Cap Gauge.....	461.00
<b>HCGK-40</b>	4" (102 mm) Cap Gauge.....	474.00
<b>HCGK-40S</b>	4" (102 mm) Cap Gauge Storz.....	402.00
<b>HCGK-45</b>	4 1/2" (114 mm) Cap Gauge.....	482.00
<b>HCGK-50</b>	5" (127 mm) Cap Gauge.....	500.00
<b>HCGK-50S</b>	5" (127 mm) Cap Gauge Storz.....	470.00
<b>HCGK-60</b>	6" (153 mm) Cap Gauge.....	564.00
<b>HCGK-60S</b>	6" (153 mm) Cap Gauge Storz.....	617.00

Style	Description	US\$ List Price
<b><u>Test Gauge Kits</u></b>		
<b>ATGK-2</b>	3 1/2" (89 mm) Test Gauge Kit.....	676.00
<b>ATGK-3</b>	3 1/2" (89 mm) Test Gauge Kit.....	695.00
<b>ATGK-2-HP</b>	3 1/2" (89 mm) High Pressure Test Gauge Kit.....	983.00
<b><u>Hand Held Tachometer</u></b>		
<b>HT-7010</b>	Digital Hand Held Tachometer with Contact Tips.....	1,029.00
<b>HT-7000</b>	Digital Hand Held Tachometer Only.....	899.00
<b>HT-7001</b>	Contact Tips - Includes one flat, one chrome, one adapter.....	181.00
<b><u>Line Gauges</u></b>		
<b>HLGK-15</b>	1 1/2" (38 mm) Line Gauge.....	434.00
<b>HLGK-25</b>	2 1/2" (65 mm) Line Gauge.....	444.00
<b>HLGK-30</b>	3" (75 mm) Line Gauge.....	648.00
<b>HLGK-35</b>	3 1/2" (89 mm) Line Gauge.....	680.00
<b>HLGK-40</b>	4" (102 mm) Line Gauge.....	694.00
<b>HLGK-45</b>	4 1/2" (114 mm) Line Gauge.....	713.00
<b>HLGK-50</b>	5" (127 mm) Line Gauge.....	954.00
<b><u>Bleeder Cap only, No Gauge</u></b>		
<b>BLCP-15</b>	1 1/2" (38 mm) Bleeder Cap.....	136.00
<b>BLCP-25</b>	2 1/2" (65 mm) Bleeder Cap.....	164.00
<b>BLCP-30</b>	3" (75 mm) Bleeder Cap.....	245.00
<b>BLCP-35</b>	3 1/2" (89 mm) Bleeder Cap.....	303.00
<b>BLCP-40</b>	4" (102 mm) Bleeder Cap.....	314.00
<b>BLCP-40S</b>	4" (102 mm) Bleeder Cap Storz.....	242.00
<b>BLCP-45</b>	4 1/2" (114 mm) Bleeder Cap.....	325.00
<b>BLCP-50</b>	5" (127 mm) Bleeder Cap.....	341.00
<b>BLCP-50S</b>	5" (127 mm) Bleeder Cap Storz.....	341.00
<b>BLCP-60</b>	6" (153 mm) Bleeder Cap.....	460.00
<b>BLCP-60S</b>	6" (153 mm) Bleeder Cap Storz.....	460.00
<b><u>Forcible Entry Tools</u></b>		
<b>HRTF</b>	HRT Pro Personal Hand Tool.....	104.00
<b>HRTF-SHEATH</b>	Sheath for HRTF.....	52.00
<b>TRI-24</b>	24" (.6 m) Tri-Bar Forcible Entry Tool.....	254.00
<b>TRI-30</b>	30" (.76 m) Tri-Bar Forcible Entry Tool.....	280.00
<b>TRI-30-ORG</b>	30" (.76 m) Tri-Bar Forcible Entry Tool (orange).....	280.00
<b>TRI-30-SLV</b>	30" (.76 m) Tri-Bar Forcible Entry Tool (silver).....	280.00
<b>TRI-36</b>	36" (.91 m) Tri-Bar Forcible Entry Tool.....	304.00
<b>TRI-36-ORG</b>	36" (.91 m) Tri-Bar Forcible Entry Tool (orange).....	304.00
<b>TRI-36-SLV</b>	36" (.91 m) Tri-Bar Forcible Entry Tool (silver).....	304.00
<b>TRI-42</b>	42" (1.05 m) Tri-Bar Forcible Entry Tool.....	334.00
<b>TRI-CS</b>	Carrying Strap for Tri-Bar or HRTF.....	32.00
<b>TRI-MS</b>	Marrying Strap for Tri-Bar to Flat Head Axe.....	17.00
<b>IRONS-30-WF6</b>	Set Includes TRI-30, WF-6, TRI-CS and TRI-MS.....	381.00
<b>IRONS-ORG30-WF6</b>	Set Includes TRI-30-ORG, WF-6, TRI-CS and TRI-MS.....	381.00
<b>IRONS-30-FHY6</b>	Set Includes TRI-30, FHY-6, TRI-CS and TRI-MS.....	392.00
<b>IRONS-ORG30-FHY6</b>	Set Includes TRI-30-ORG, FHY-6, TRI-CS and TRI-MS.....	392.00
<b>IRONS-BF-30</b>	Set Includes TRI-30, BF-8, TRI-CS and TRI-MS.....	562.00
<b>IRONS-BF-ORG30</b>	Set Includes TRI-30-ORG, BF-8, TRI-CS and TRI-MS.....	562.00
<b>RF-36</b>	36" (.91 m) Rapid Force™ Forcible Entry Tool.....	309.00
<b>BF-8</b>	Brute Force™ Forcible Entry Tool.....	250.00
<b><u>Pinch Point Bars and Bracket</u></b>		
<b>PPB-36</b>	36" (.9 m) Pinch Point Bar.....	51.00
<b>PPB-51</b>	51" (1.3 m) Pinch Point Bar.....	65.00
<b>PPB-60</b>	60" (1.5 m) Pinch Point Bar.....	85.00
<b>PPBH</b>	Pinch Point Bar Holder Set.....	85.00



Style	Description	US\$ List Price
<b>Roof Hooks</b>		
ARH-17	17" (4.3 m) with multipurpose hook and chisel.....	62.00
ARH-24	24" (6 m) with multipurpose hook and chisel.....	77.00
ARH-36	36" (9 m) with multipurpose hook and chisel.....	88.00
ARH-36S	36" (9 m) with multipurpose hook, chisel and strap.....	99.00
ARH-48	48" (1.20 m) with multipurpose hook and chisel.....	99.00
ARH-48S	48" (1.20 m) with multipurpose hook, chisel and strap.....	110.00
ARH-60	60" (1.52 m) with multipurpose hook and chisel.....	110.00
ARH-72	72" (1.83 m) with multipurpose hook and chisel.....	122.00
ARH-96	96" (2.44 m) with multipurpose hook and chisel.....	130.00
Additional Charge for:		
	FC - Fulcrum Chisel.....	21.00
	BH - Boston Hook.....	20.00
	RK - Ram Knob.....	23.00

\*Length based on overall length of tool including head and foot  
 Note: An additional charge of **\$35.00 net** will be added to order for any standard color other than Black. Standard Colors: Red, Yellow, Silver, Green and White.

<b>Gorilla Hooks</b>		
AGH-36	36" (9 m) with multipurpose hook and fulcrum chisel.....	142.00
AGH-36S	36" (9 m) with multipurpose hook, fulcrum chisel, strap.....	162.00
AGH-48	48" (1.2 m) with multipurpose hook and fulcrum chisel.....	152.00
AGH-48S	48" (1.2 m) with multipurpose hook, fulcrum chisel, strap.....	172.00
AGH-72	72" (1.83 m) with multipurpose hook and fulcrum chisel.....	174.00
AGH-72S	72" (1.83 m) with multipurpose hook and fulcrum chisel.....	195.00

\*Length based on overall length of tool including head and foot

<b>Axes and Sledge Hammers</b>		
PHY-6	6# Pick Head Axe with 36" (9 m) Fiberglass Handle.....	91.00
FHY-6	6# Flat Head Axe with 36" (9 m) Fiberglass Handle.....	83.00
WP-6	6# Pick Head Axe with 36" (9 m) Hickory Handle.....	72.00
WF-6	6# Flat Head Axe with 36" (9 m) Hickory Handle.....	69.00
PHY-8	8# Pick Head Axe with 36" (9 m) Fiberglass Handle.....	206.00
FHY-8	8# Flat Head Axe with 36" (9 m) Fiberglass Handle.....	209.00
FSY-8	8# Sledge Hammer with 36" (9 m) Fiberglass Handle.....	77.00
FSY-10	10# Sledge Hammer with 36" (9 m) Fiberglass Handle.....	87.00
FSY-12	12# Sledge Hammer with 36" (9 m) Fiberglass Handle.....	98.00

<b>Axe Brackets and Accessories</b>		
P-APC	Pick Head Axe Cover with Chain.....	22.00
AS-510	Axe Blade Bracket For Horizontal Mounting with 3/8" (9.5 mm) Poly Spacer.....	48.00
AS-520	Axe Handle Bracket.....	50.00
AS-530	Axe Blade Bracket For Vertical Mounting 6# Pick Axe.....	42.00
AS-540	Axe Blade Bracket For Vertical Mounting 6# Flat Axe.....	42.00
AS-550	Axe Blade Bracket For Vertical Mounting 8# Pick Axe.....	42.00
AS-560	Axe Blade Bracket For Vertical Mounting 8# Flat Axe.....	42.00
AS-570	Sledge Hammer Bracket For Vertical Mounting 8#, 10# and 12# Hammers.....	42.00
511-SP	1/4" (6.4 mm) Poly Spacer for 8# Axes.....	12.00

<b>Axes, Sledge Hammers and Mounting Bracket Sets</b>		
PHY-6-HMT	6# Pick Head Axe with Horizontal Mounting Brackets and Pick Cover.....	211.00
PHY-6-VMT	6# Pick Head Axe with Vertical Mounting Brackets and Pick Cover.....	205.00
FHY-6-HMT	6# Flat Head Axe with Horizontal Mounting Brackets.....	181.00
FHY-6-VMT	6# Flat Head Axe with Vertical Mounting Brackets.....	175.00
WP-6-HMT	6# Pick Head Axe with Horizontal Mounting Brackets.....	192.00
WP-6-VMT	6# Pick Head Axe with Vertical Mounting Brackets and Pick Cover.....	186.00
WF-6-HMT	6# Flat Head Axe with Horizontal Mounting Brackets.....	167.00
WF-6-VMT	6# Flat Head Axe with Vertical Mounting Brackets.....	161.00
PHY-8-HMT	8# Pick Head Axe with Horizontal Mounting Brackets and Pick Cover.....	326.00
PHY-8-VMT	8# Pick Head Axe with Vertical Mounting Bracket and Pick Cover.....	320.00
FHY-8-HMT	8# Flat Head Axe with Horizontal Mounting Brackets.....	307.00
FHY-8-VMT	8# Flat Head Axe with Vertical Mounting Brackets.....	301.00
FSY-8-VMT	8# Sledge Hammer with Vertical Mounting Brackets.....	184.00
FSY-10-VMT	10# Sledge Hammer with Vertical Mounting Brackets.....	194.00

Style	Description	US\$ List Price
<b>Wildland Fire Tools</b>		
FSS-MT	Forestry Service McLeod Tool.....	122.00
FB-42	Fire Fighting Broom.....	43.00
FR-12	Fire Rake with 60" (1.5 m) Wooden Handle and Head.....	41.00
FR-60F	Fire Rake with 60" (1.5 m) Fiberglass Handle.....	76.00
UL-FR-60F	Fire Rake with 60" (1.5 m) Ultra-Lite Fiberglass Handle.....	51.00
FB-15	Fire Beater with 60" (1.5 m) Wooden Handle.....	55.00
FB-60F	Fire Beater with 60" (1.5 m) Fiberglass Handle.....	81.00
UL-FB-60F	Fire Beater with 60" (1.5 m) Ultra-Lite Fiberglass Handle.....	66.00
UL-MT-48	McLeod tool with 48" (1.2 m) Ultra-Lite Fiberglass Handle.....	86.00
WR-MT-48	McLeod tool with 48" (1.2 m) Wood Handle.....	85.00
WPL-4	3.75# Pulaski Axe with 36" (9 m) Hickory Handle.....	84.00

<b>Miscellaneous Tools</b>		
UL-SQ-60F	18" (5 m) Floor Squeegee with 60" (1.5 m) Ultra-Lite Fiberglass Handle.....	117.00
UL-SQ-60F24	24" (6 m) Floor Squeegee with 60" (1.5 m) Ultra-Lite Fiberglass Handle.....	124.00
UL-DG-SQ	18" (5 m) Floor Squeegee with 60" (1.5 m) Double Ultra-Lite Fiberglass Handle.....	158.00
UL-DG-SQ24	24" (6 m) Floor Squeegee with 60" (1.5 m) Double Ultra-Lite Fiberglass Handle.....	162.00
RS-48F	Round Shovel with 48" (1.2 m) Ultra-Lite Fiberglass Handle.....	70.00
SS-48F	Square Shovel with 48" (1.2 m) Ultra-Lite Fiberglass Handle.....	62.00
AS-27D	Scoop Shovel with 27" (7 m) Ultra-Lite Fiberglass Rod and D-Handle.....	89.00
DB-48	48" (1.2 m) Demolition Bar.....	144.00
WYNN-5D	5' (1.5 m) Steel pole with chisel tip, angled pike and D-Handle.....	283.00
WYNN-6D	6' (1.8 m) Steel pole with chisel tip, angled pike and D-Handle.....	311.00

<b>Super Spanners</b>		
SS-525	Spanner Wrenches 4-5" (102-127 mm) Storz and 1-3" (2.5-75 mm) Rocker Lugs.....	28.00
SS-523	Spanner Wrenches 4-5" (102-127 mm) Storz with Handle.....	40.00
SS-MP	Mounting Plate with four (4) SS-525 Super Spanner Wrenches.....	139.00
SS-523-MP	Mounting Plate with 4 SS-523.....	160.00
SS-MPX	Mounting Plate Only.....	51.00

**Style Description US\$ List Price**

**Pike Poles**

**How to Order Pike Poles:**

Select one option from each column to build your part #.

Pole	Length	Handle	Pike
UL = Ultra-Lite	3' (9 m)	___ = Butt End	___ = Standard Hook
UL-DG = Ultra-Lite Double Gripper	4' (1.2 m)	D = D-Handle	DWH = Drywall Hook
IB = I-Beam	6' (1.8 m)	RK = Ram Knob	RH = Rubbish Hook
PP = Gripper	8' (2.4 m)	HD = Wide D-Hdl	MP = Multipurpose w/Ram Knob
DG = Double Gripper	10' (3.0 m)		D-MP = Multipurpose w/D-Handle
WR = Wood	12' (3.7 m)		SH = Shredder
UT = Ultra-Tough	14' (4.3 m)		LARH = 3/4" (19 mm) Rubbish Hook
	16' (4.9 m)		

Example:

UL \_\_\_ 14 \_\_\_ \_\_\_ DWH

UL-14-DWH = 14' Ultra-Lite Pike Pole with Drywall Hook

**PIKE POLE FREIGHT: All Pike Pole & Hand Tool Purchases are F.O.B. factory regardless of discount structure. Freight Free shipments of Pike Poles & Hand Tools can be obtained with a minimum order for a single shipment to one location of \$950.00 net cost. Does not apply to International orders.**

**Pike Pole Additional Options**

Additional Charge for:

DWH - Drywall Hook.....	40.00
P-RH - Rubbish Hook.....	35.00
LARH - 3/4" (19 mm) Rubbish Hook.....	45.00
D - D-Ring Handle.....	25.00
HD - Wide D-Handle (UL and UT only).....	25.00
RK - Ram Knob.....	23.00
MP - Multipurpose Hook with Ram Knob (Ram Knob included with MP at no charge when purchased as part of a complete pole; this option not available with WR poles).....	38.00
D-MP - Multipurpose Hook with D Handle (not available with WR poles).....	44.00
SH - Shredder (not available with WR poles).....	45.00
148-BT - 8" (203 mm) Band of Grip Tape.....	8.00
325-OE - Additional Grip.....	9.00

\*Specialty hooks & ends add to the overall length of the pike pole

**Ultra-Tough Pike Pole**

UT-3 3' (9 m) Pike Pole with Standard Hook.....	48.00
UT-4 4' (1.2 m) Pike Pole with Standard Hook.....	54.00
UT-6 6' (1.8 m) Pike Pole with Standard Hook.....	78.00
UT-8 8' (2.4 m) Pike Pole with Standard Hook.....	85.00
UT-10 10' (3.0 m) Pike Pole with Standard Hook.....	95.00
UT-12 12' (3.7 m) Pike Pole with Standard Hook.....	107.00

See pg. 34 for additional options

**Ultra-Lite Pike Pole**

UL-3 3' (9 m) Pike Pole with Standard Hook.....	46.00
UL-4 4' (1.2 m) Pike Pole with Standard Hook.....	52.00
UL-6 6' (1.8 m) Pike Pole with Standard Hook.....	77.00
UL-8 8' (2.4 m) Pike Pole with Standard Hook.....	83.00
UL-10 10' (3.0 m) Pike Pole with Standard Hook.....	93.00
UL-12 12' (3.7 m) Pike Pole with Standard Hook.....	105.00

See pg. 34 for additional options

**Double Gripper Ultra-Lite Pike Pole**

UL-DG-10 10' (3.0 m) Gripper Pike Pole with Standard Hook.....	112.00
UL-DG-12 12' (3.7 m) Gripper Pike Pole with Standard Hook.....	123.00
UL-DG-14 14' (4.3 m) Gripper Pike Pole with Standard Hook.....	132.00

**Style Description US\$ List Price**

**Double Gripper Ultra-Lite Pike Pole (cont.)**

UL-DG-16 16' (4.9 m) Gripper Pike Pole with Standard Hook.....	147.00
UL-DG-20 20' (6.1 m) Gripper Pike Pole with Standard Hook.....	182.00

See pg. 34 for additional options

**I-Beam Pike Poles**

IB-3 3' (9 m) with Standard Hook.....	75.00
IB-4 4' (1.2 m) with Standard Hook.....	83.00
IB-6 6' (1.8 m) with Standard Hook.....	95.00
IB-8 8' (2.4 m) with Standard Hook.....	105.00
IB-10 10' (3.0 m) with Standard Hook.....	120.00
IB-12 12' (3.7 m) with Standard Hook.....	135.00

See pg. 34 for additional options

**Gripper Pike Poles**

PP-3 3' (9 m) with Standard Hook and Grip.....	55.00
PP-4 4' (1.2 m) with Standard Hook and Grip.....	63.00
PP-6 6' (1.8 m) with Standard Hook and Grip.....	81.00
PP-8 8' (2.4 m) with Standard Hook and Grip.....	93.00
PP-10 10' (3.0 m) with Standard Hook and Grip.....	106.00
PP-12 12' (3.7 m) with Standard Hook and Grip.....	120.00

See pg. 34 for additional options

**Double Gripper Oval Rod**

DG-10 10' (3.0 m) with Standard Hook.....	125.00
DG-12 12' (3.7 m) with Standard Hook.....	138.00
DG-14 14' (4.3 m) with Standard Hook.....	157.00
DG-16 16' (4.9 m) with Standard Hook.....	171.00
DG-18 18' (5.5 m) with Standard Hook.....	210.00
DG-20 20' (6.1 m) with Standard Hook.....	250.00

See pg. 34 for additional options

**Wood Pike Poles**

WR-3 3' (9 m) with Standard Hook.....	52.00
WR-4 4' (1.2 m) with Standard Hook.....	63.00
WR-6 6' (1.8 m) with Standard Hook.....	92.00
WR-8 8' (2.4 m) with Standard Hook.....	104.00
WR-10 10' (3.0 m) with Standard Hook.....	135.00
WR-12 12' (3.7 m) with Standard Hook.....	182.00

**Adapt-a-Pole**

AP-SK Adapt-a-Pole Salvage Kit.....	552.00
AP-VK Adapt-a-Pole Roof Kit.....	339.00

**Adapt-a-Pole Additional Options:**

AP-3-USA - 3' (9 m) USA Hook.....	93.00
AP-3-RH - 3' (9 m) Rubbish Hook.....	119.00
AP-3-DWH - 3' (9 m) Dry Wall Hook.....	114.00
AP-3-BG - 3' (9 m) Bumper Grip.....	59.00
AP-3-DH - 3' (9 m) D-Handle.....	71.00
AP-3-EXT - 3' (9 m) Extension.....	71.00
AP-3-RK - 3' (9 m) Ram Knob.....	71.00
AP-D - 6" (153 mm) D-Handle.....	59.00
AP-AS - Scoop Shovel.....	85.00
AP-BH - Broom Head.....	130.00
AP-4-EXT - 4' (1.2 m) Extension.....	70.00
AP-4-BG - 4' (1.2 m) Handle Section.....	58.00
AP-4-DH.....	78.00
AP-SH - Shovel Head.....	71.00
AP-SQ - Squeegee Head.....	101.00

\*Specialty hooks & ends add to the overall length of the pike pole

**Pike Pole Mounting Brackets**

PPBK Tool Brackets 3/4 - 1 1/8" (19 - 29 mm).....	18.00
PPBK-LG Tool Brackets 1 3/8 - 1 3/4" (35 - 44 mm).....	19.00
HM-58 Horizontal Tool Bracket 1 1/8" (29 mm).....	61.00
HM-59 Horizontal Tool Bracket 1 1/2" (38 mm).....	48.00
VM-58 Vertical Tool Bracket 1 1/8" (29 mm).....	66.00
VM-59 Vertical Tool Bracket 1 1/2" (38 mm).....	55.00
PPR-60 Pike Pole Rings.....	44.00
148-BT Optional 8" (203 mm) Band of Grip Tape.....	9.00

**Style Description US\$ List Price**

**Extenda-Lite®**

How to Order Extenda-Lite® products:  
 Select one option from each of the first three columns and as many as you need from the fourth column to build your part #.  
 The sum of the component prices is your list price.

Light Head	Base or Pole	Bracket	Additional Options
ELST-150	Portable Light (PL)	SM2	PLMT
ELST-300	Tripod (POD)	SM4	POD-Bracket
ELST-500	Pull Up Pole (PU)	FM	SC
ELST-1000	Push Up Pole (PS)	TM	SC-171
ELST-1500	Air Operated Pole (AO)	TM-EX	KO
ELST-12V1	Non-Telescoping Swivel Base (SB)	TR	FM-Spacer
ELST-12V2	Recessed Mount (RM) *	HK-LKi	HC-2
EJDM	Brow Light (BL) **	HK2-LKi	HC-2SC
ELBE-150	Manual Mast (MMST)		HC-4
ELBE-300	Pedestal Mount (PM)		HC-4SC
ELBE-500	DIN Mount (DIN)		WG
ELBE-650			SW
ELBE-750			UI
ELNB-150			PL-POLE-MT
ELNB-300			NM-2
ELNB-500			NM-4
ELNB-650			TL
ELNB-750			WO
ELSS-SLDC			DH
ELSS-XLDC			
ELSS-XLAC			
ELSS-SLAC			
ELSL-1000	* Available with ELBE (Beta), ELSS-SLDC or ELSS-SLAC (SceneStar®) lights only		
ELSB-WS360	** Available with ELBE (Beta) or any ELSS (SceneStar®) light only		

Example: ELST - 500 - POD - - WG - POD-Bracket  
 List Price: 303.00 +584.00 +55.00 +143.00 = 1,085.00 List Price  
 ELST-500-POD-WG-POD-Bracket = 500 watt ST Series light head tripod with Wire Guard and Pod Bracket  
 For Poles only, simply omit any part number for the light head. For example, to order a tripod without a light head order as: POD - POD-Bracket

**Extenda-Lite® Light Heads**

<b>ELST-150</b>	ST Series 150 Watt Light Head Only 12V.....	404.00
<b>ELST-300</b>	ST Series 300 Watt Light Head Only 120V or 240V.....	303.00
<b>ELST-500</b>	ST Series 500 Watt Light Head Only 120V or 240V.....	303.00
<b>ELST-1000</b>	ST Series 1000 Watt Light Head Only 120V or 240V.....	386.00
<b>ELST-1500</b>	ST Series 1500 Watt Light Head Only 120V or 240V.....	403.00
<b>ELST-12V1</b>	ST Series 12V Single 200,000 Spot / 100 Watt Flood.....	338.00
<b>ELST-12V2</b>	ST Series 12V Dual 200,000 Spot / 100 Watt Flood.....	487.00
<b>EJDM</b>	Daymaker 12V.....	649.00
<b>ELBE-150</b>	Low Profile Beta 12V 150 Watt Light Head Only.....	464.00
<b>ELBE-300</b>	Low Profile Beta 300 Watt Light Head Only 120V.....	416.00
<b>ELBE-500</b>	Low Profile Beta 500 Watt Light Head Only 120V or 240V.....	416.00
<b>ELBE-650</b>	Low Profile Beta 650 Watt Light Head Only 120V.....	460.00
<b>ELBE-750</b>	Low Profile Beta 750 Watt Light Head Only 120V.....	451.00
<b>ELNB-150</b>	Night Breaker 150 Watt HID Light Head Only 12V.....	1,271.00
<b>ELNB-300</b>	Night Breaker 300 Watt Light Head Only 120V.....	414.00
<b>ELNB-500</b>	Night Breaker 500 Watt Light Head Only 120V.....	414.00
<b>ELNB-650</b>	Night Breaker 650 Watt Light Head Only 120V.....	465.00
<b>ELNB-750</b>	Night Breaker 750 Watt Light Head Only 120V.....	446.00
<b>ELSS-SLDC</b>	SceneStar™ 14000 Lumen Akron LED Head Only.....	1,369.00

**Style Description US\$ List Price**

**Extenda-Lite® Light Heads (cont.)**

<b>ELSS-SLAC</b>	SceneStar™ 15000 Lumen Akron LED Head Only (120V or 240V, for RM mounting only).....	1,369.00
<b>ELSS-XLDC</b>	SceneStar™ 19000 Lumen Akron LED Head Only.....	1,658.00
<b>ELSS-XLAC</b>	SceneStar™ 20000 Lumen Akron LED Head Only 120V or 240V.....	1,658.00
<b>ELSL-1000</b>	1000 Watt SuperLight Head Only.....	622.00
<b>ELSB-WS360</b>	360 Degree Strobe (specify Green, Amber, Red or Clear).....	486.00

**Extenda-Lite® Base or Pole Options**

<b>PL</b>	Portable Light Base with AC Plug (L5-15 standard).....	110.00
	Requires PL-Pole-MT if you wish to mount PL on a Pole	
<b>POD</b>	Tripod with AC Plug (L5-15 Standard)	
	Specify Stowed Height: 36", 43", 54", 64", 72".....	584.00
<b>PU</b>	Pull-Up Style Pole (for use with SM, FM, TM, or TM-EX brackets)	
	Specify Inside and Outside Pole Lengths (48" x 58" standard)	
	.....	269.00
<b>PS</b>	Push-Up Style Pole (for use with SM or TR brackets)	
	Specify Inside and Outside Pole Lengths (60" x 11.5" standard)	
	.....	269.00
<b>AO</b>	Air Operated Pole (for use with SM or FM brackets)	
	Air Control Box Included.....	1,140.00
<b>SB</b>	Non-Telescoping Swivel Base (fixed or can be used with SM4).....	157.00
<b>RM</b>	Recessed Mount (specify 0 or 16 degree down angle)*.....	163.00
<b>BL</b>	Brow Mount Light**.....	140.00
<b>MMST</b>	Manual Mast.....	526.00
<b>PL-Pole-MT</b>	Mounting Bracket For PL-Series on a Pole.....	117.00
<b>PM</b>	Pedestal Mount.....	150.00
<b>DIN</b>	DIN Mount.....	270.00

**Extenda-Lite® Bracket Options**

<b>SM2</b>	Pair of 2-1/8" offset Side Mount Brackets for Pull-Up or Push-Up Pole.....	110.00
<b>SM4</b>	Pair of 4-1/4" offset Side Mount Brackets for Pull-Up or Push-Up Pole.....	110.00
<b>FM-Bracket</b>	Pair of Flush Mount Brackets for Pull-Up or AO Pole.....	110.00
<b>TM</b>	Top Mount Bracket for Pull-Up Pole.....	56.00
<b>TM-EX</b>	Extrusion Bracket for Pull-Up Pole.....	56.00
<b>TR</b>	Through the Roof Bracket for Push-Up Pole.....	106.00
<b>HK-LKi</b>	Light Kit Only for Honda EU1000i (5-15 Plug Only).....	243.00
<b>HK2-LKi</b>	Light Kit Only for Honda EU2000i (5-15 Plug Only).....	271.00

**Extenda-Lite® Additional Options and/or Replacement Components**

When ordering Additional Extenda-Lite® Options, add the option I.D. listed below for the particular option as a suffix to the part number.

<b>PLMT</b>	Mounting Bracket for PL-Series Lights.....	60.00
<b>POD-Bracket</b>	3-Piece Tripod Mounting System.....	143.00
<b>POD-Bracket-Long</b>	3-Piece Tripod Mounting System with 3" (75 mm) offset.....	143.00
<b>SC</b>	Stop Collar (2 Pieces) For Inside Pole.....	41.00
<b>SC-171</b>	Stop Collar For Outside Pole.....	41.00
<b>KO</b>	Knurled Outside Pole.....	51.00
<b>SM2</b>	Side Mount Bracket 2 1/8" (54 mm) Offset 4.....	56.00
<b>SM4</b>	Side Mount Bracket 4 1/4" (108 mm) Offset.....	56.00
<b>FM-Bracket</b>	Flush Mount Bracket.....	56.00
<b>FM-Spacer</b>	Spacer for Flush Mount 1/2" (13 mm) Thick.....	56.00
<b>TM</b>	Top Mount Bracket.....	56.00
<b>TM-EX</b>	Extrusion Bracket.....	56.00
<b>TR</b>	Through the Roof Bracket.....	106.00
<b>HC-2</b>	Handle Cup for Push-Up Lights with 2 1/8" (54 mm) Offset.....	56.00
<b>HC-2SC</b>	Handle Cup with stop 2 1/8" (54 mm) Offset.....	56.00
<b>HC-4</b>	Handle Cup for Push-Up Lights with 4 1/8" (108 mm) Offset.....	56.00
<b>HC-4SC</b>	Handle Cup with stop 4 1/4" (108 mm) Offset.....	56.00
<b>WG</b>	Chrome Plated Wire Guard.....	55.00

Style	Description	US\$ List Price
<b>Extenda-Lite® Additional Options and/or Replacement Components (cont.)</b>		
SW	Switch for Light Head.....	47.00
UI	Up Indicator Switch .....	106.00
NM-2	No Mark Kit at 2" (51 mm).....	134.00
NM-4	No Mark Kit at 4" (102 mm).....	134.00
TL	Locking Collar for Telescopic Poles .....	63.00
WO	Wire Out the Top of the Pole .....	No Charge

*For Dual Head Options, Add the Price Listed to the Price of the Assembly*

DH	ELST-150.....	459.00
DH	ELST-300.....	358.00
DH	ELST-500.....	358.00
DH	ELST-1000.....	441.00
DH	ELST-1500.....	458.00
DH	ELST-12V1.....	393.00
DH	ELBE-300.....	471.00
DH	ELBE-500.....	471.00
DH	ELBE-650.....	515.00
DH	ELBE-750.....	506.00
DH	ELNB-300.....	469.00
DH	ELNB-500.....	469.00
DH	ELNB-650.....	520.00
DH	ELNB-750.....	501.00
DH	ELSS-XLAC.....	1,716.00

**Replacement Lamps Only**

CDM150-TD-942	150 Watt 12V Metal Halide Bulb .....	165.00
Q300-120CL-T3	300 Watt 120V Quartz Halogen.....	20.00
Q300-240CL-T3	300 Watt, 240V Quartz Halogen.....	20.00
Q500-120CL-T3	500 Watt, 120V Quartz Halogen .....	20.00
Q500-240CL-T3	500 Watt 240V Quartz Halogen .....	20.00
FCM-HIRQ650T3	650 Watt 120V Quartz Halogen .....	134.00
Q750-120CL-T3	750 Watt 120V Quartz Halogen .....	51.00
Q1000-110CL-T3	1000 Watt 120V Quartz Halogen .....	41.00
Q1000-240CL-T3	1000 Watt 240V Quartz Halogen .....	41.00
Q1500-110CL-T3	1500 Watt 120V Quartz Halogen .....	41.00
Q1500-240CL-T3	1500 Watt 240V Quartz Halogen .....	41.00
Q2000-230CL-T3	2000 Watt 240V Quartz Halogen .....	75.00
Q150-12VDC-T3	150 Watt 12V Quartz Halogen .....	75.00
4007	12V Lamps 200,000 Candlepower Spot and 100 Watt Flood.....	33.00
MH1000-U-BT-37	1000 Watt 120V Metal Halide Bulb.....	98.00

**Class 1, Div. 2 Hazardous Location SceneStar™**

ELSS-XLAC-HDPL	20000 Light with PL Base Select cord length of 5' (1.5m) or 50' (15m).....	2,400.00
ELSS-XLAC-HDPD	20000 Light with POD Base Select cord length of 5' (1.5m) or 50' (15m).....	3,400.00

Style	Description	US\$ List Price
<b>Honda Generators</b>		
EU-1000iK1	1000 Watt Inverter Generator.....	1,734.00
EU-2000iIA	2000 Watt Inverter Generator.....	2,370.00
EU-3000iS1	3000 Watt Inverter Generator.....	4,222.00
EM-5000iS	5000 Watt Inverter Generator (Deluxe Series) .....	7,374.00
EU-7000iS	6500 Watt Inverter Generator .....	8,550.00

**Honda Generator Light Kit**  
*Select a 1000 or 2000 watt generator (above), the matching mounting bracket (HK-LKi or HK2-LKi) and a Light Head (page 35). Examples:*

ELST-500-HG	Honda EU1000iK1 Generator with 500 Watt Light .....	2,280.00
ELSS-XLAC-HG	Honda EU1000iK1 Generator with 20,000 Lumen Light ...	3,635.00
ELBE-750-HG	Honda EU1000iK1 Generator with Low Profile Beta 750 Watt Light.....	2,423.00
ELST-500-HG2	Honda EU2000iIA Generator with 500 Watt Light.....	2,944.00
ELST-1000-HG2	Honda EU2000iIA Generator with 1000 Watt Light .....	3,027.00
ELST-1500-HG2	Honda EU2000iIA Generator with 1500 Watt Light.....	3,044.00
ELSS-XLAC-HG2	Honda EU2000iIA Generator with 20,000 Lumen Light.....	4,299.00
ELBE-500-HG2	Honda EU2000iIA Generator with Low Profile Beta 500 Watt Light.....	3,057.00
ELBE-750-HG2	Honda EU2000iIA Generator with Low Profile Beta 750 Watt Light .....	3,092.00

**Light Head Kit Only for Honda EU1000iK1**  
*Select a Light Head (page 35) and HK-LKi. Examples:*

ELST-500-HK-LKi	500 Watt 120V ST Series Light .....	546.00
ELSS-XLAC-HK-LKi	20,000 Lumen SceneStar™ Light.....	1,901.00
ELNB-750-HK-LKi	750 Watt 120V Night Breaker Light.....	689.00
ELBE-650-HK-LKi	650 Watt 120V Low Profile Beta Light.....	703.00

**Light Head Kit Only for Honda EU2000iIA**  
*Select a Light Head (page 35) and HK2-LKi. Examples:*

ELST-500-HK2-LKi	500 Watt 120V ST Series Light.....	574.00
ELSS-XLAC-HK2-LKi	20,000 Lumen SceneStar™ Light.....	1,929.00
ELNB-750-HK2-LKi	750 Watt 120V Night Breaker Light.....	717.00
ELST-1000-HK2-LKi	1000 Watt 120V ST Series Light .....	657.00
ELST-1500-HK2-LKi	1500 Watt 120V ST Series Light.....	674.00
ELBE-650-HK2-LKi	650 Watt 120V Low Profile Beta Light .....	731.00

**Honda Pumps**  
**Dewatering**

WX10K1AT	1.0" Lightweight Centrifugal Pump.....	866.00
WX15AX2	1.5" Lightweight Centrifugal Pump.....	1,019.00
WB20XK2	2.0" General Purpose Centrifugal Pump .....	888.00
WB30XK2	3.0" General Purpose Centrifugal Pump.....	1,127.00
WH15XK1	1.5" High Pressure Centrifugal Pump.....	1,388.00
WH20XK1A	2.0" High Pressure Centrifugal Pump.....	1,480.00

**Multi-Purpose**

WMP20XA	2.0" Multi-Purpose Centrifugal Pump.....	1,127.00
---------	--	----------

**Construction - Trash**

WT20XK3A	2.0" Trash Centrifugal Pump.....	2,452.00
WT30XK3A	3.0" Trash Centrifugal Pump.....	2,892.00
WT40XK2A	4.0" Trash Centrifugal Pump.....	4,364.00

**Construction - Diaphragm**

WDP30XK1AT	3.0" Diaphragm Pump.....	4,135.00
------------	--------------------------	----------

**Submersible**

WSP33K1AA	1/3 hp Submersible Standard Pump.....	503.00
WSP53AA	1/2 hp Submersible Standard Pump .....	1,062.00
WSP73AA	3/4 hp Submersible Standard Pump.....	1,170.00
WSP50A	1/2 hp Submersible Trash Pump.....	1,349.00
WSP100A	1 hp Submersible Trash Pump.....	1,534.00

Prices are for U.S. domestic resale and do not include International Tariffs, Taxes and Shipping  
 ♦ : denotes a \$68.00 per inlet upcharge if fitted with British Instantaneous (BIM or BIF), Japanese Instantaneous (JIM or JIF), or Storz connections



Style	Description	US\$ List Price
<b>Booster Hose Reels (Front Access Manual Override)</b>		
MRWB-xx-xx	Manual Rewind Booster Reel (see below for disc size and spacing options).....	1,454.00
<b>Options for Manual or Electric Rewind Booster Reel:</b>		
ERWB-30DEG	30 degree Manual Access Rewind Crank.....	39.00
ERWB-VERT	Vertical Access Manual Rewind Crank.....	100.00
ERWB-GR-xx-xx	Guide Rollers for Booster Reel specify reel size .....	298.00
ERWB-GR-xx-xx-BX	Box Guide Rollers for Booster Reel (specify reel size).....	471.00
ERWB-GR-xx-xx-BX-LP	Box Guide Rollers that are Low Profile for Booster Reel (specify reel size).....	471.00
ERWB-xx-xx	Electric Rewind Booster Reel (see below for disc size and spacing options).....	1,937.00
<b>Options for Electric Rewind Booster Reel Only:</b>		
ERW-SCS	Speed Control.....	498.00
ERW-SL-ASSY	Control Box Only to House Switch.....	24.00
<b>1/2 HP Motor Option</b>		
	Specify 12V or 24V.....	142.00

**Available Sizes:**

*(Indicate MRWB for manual reel or ERWB for electric reel when ordering)*

Name	Disc Size x Space Between Discs	3/4" Hose Capacity	1" Hose capacity
xxxx-16-24	16" Disc x 24" Spacing	125' (38m)	75' (23m)
xxxx-16-28	16" Disc x 28" Spacing	150' (46m)	100' (31m)
xxxx-22-11	22" Disc x 11" Spacing	125' (38m)	75' (23m)
xxxx-22-15	22" Disc x 15" Spacing	175' (54m)	100' (31m)
xxxx-22-20	22" Disc x 20" Spacing	225' (69m)	150' (64m)
xxxx-22-24	22" Disc x 24" Spacing	300' (92m)	200' (61m)
xxxx-22-28	22" Disc x 28" Spacing	350' (107m)	225' (69m)
xxxx-24-11	24" Disc x 11" Spacing	150' (46m)	100' (31m)
xxxx-24-15	24" Disc x 15" Spacing	225' (69m)	125' (38m)
xxxx-24-20	24" Disc x 20" Spacing	300' (92m)	175' (54m)
xxxx-27-11	27" Disc x 11" Spacing	225' (69m)	150' (46m)
xxxx-27-15	27" Disc x 15" Spacing	300' (92m)	200' (61m)
xxxx-27-20	27" Disc x 20" Spacing	400' (122m)	250' (77m)
xxxx-29-11	29" Disc x 11" Spacing	250' (77m)	175' (54m)
xxxx-29-15	29" Disc x 15" Spacing	350' (107m)	225' (69m)
xxxx-29-20	29" Disc x 20" Spacing	450' (138m)	300' (92m)

**Booster Hose for ERWB and MRWB with aluminum fittings:**

W34-50-NST	Booster Hose, 3/4" (19 mm) x 50' (15.24 m).....	506.00
W34-100-NST	Booster Hose, 3/4" (19 mm) x 100' (30.48 m).....	896.00
W34-150-NST	Booster Hose, 3/4" (19 mm) x 150' (45.72 m).....	1,285.00
W34-200-NST	Booster Hose, 3/4" (19 mm) x 200' (60.96 m).....	1,661.00
W34-90M-NST	Booster Hose, 3/4" (19 mm) x 90 m (295 ft.) NST.....	2,757.00
W1-50-NST	Booster Hose, 1" (25 mm) x 50' (15.24 m).....	577.00
W1-100-NST	Booster Hose, 1" (25 mm) x 100' (30.48 m).....	1,034.00
W1-150-NST	Booster Hose, 1" (25 mm) x 150' (45.72 m).....	1,493.00
W1-200-NST	Booster Hose, 1" (25 mm) x 200' (60.96 m).....	1,873.00
FRSTI-50-NPSH	1" (25 mm) x 50' (15.24 m) Boostlite® Forestry Hose, pin lug fittings, NPSH thread.....	466.00
FRSTI-50-NPSH-RL	1" (25 mm) x 50' (15.24 m) Boostlite® Forestry Hose, rocker lug fittings, NPSH thread.....	413.00
FRSTI-50-NST	1" (25 mm) x 50' (15.24 m) Boostlite® Forestry Hose, pin lug fittings, NST thread.....	466.00

Style	Description	US\$ List Price
<b>Booster Hose for ERWB and MRWB with aluminum fittings: (cont.)</b>		
FRSTI-50-NST-RL	1" x 50' (15.24 m) Boostlite® Forestry Hose, Rocker lug fittings, NST thread.....	413.00
FRSTI-100-NPSH	1" (25 mm) x 100' (30.48 m) Boostlite® Forestry Hose, Pin lug fittings, NPSH thread.....	816.00
FRSTI-100-NPSH-RL	1" (25 mm) x 100' (30.48 m) Boostlite® Forestry Hose, Rocker lug fittings, NPSH thread.....	764.00
FRSTI-100-NST	1" x 100' (30.48 m) Boostlite® Forestry Hose, Pin lug fittings, NST thread.....	816.00
FRSTI-100-NST-RL	1" (25 mm) x 100' (30.48 m) Boostlite® Forestry Hose, Rocker lug fittings, NST thread.....	764.00
FRSTI-150-NPSH	1" (25 mm) x 150' (45.72 m) Boostlite® Forestry Hose, Pin lug fittings, NPSH thread.....	1,231.00
FRSTI-150-NPSH-RL	1" (25 mm) x 150' (45.72 m) Boostlite® Forestry Hose, Rocker lug fittings, NPSH thread.....	1,168.00
FRSTI-150-NST	1" (25 mm) x 150' (45.72 m) Boostlite® Forestry Hose, Pin lug fittings, NST thread.....	1,231.00
FRSTI-150-NST-RL	1" (25 mm) x 150' (45.72 m) Boostlite® Forestry Hose, Rocker lug fittings, NST thread.....	1,168.00
FRSTI-200-NPSH	1" (25 mm) x 200' (60.96 m) Boostlite® Forestry Hose, Pin lug fittings, NPSH thread.....	1,572.00
FRSTI-200-NPSH-RL	1" (25 mm) x 200' (60.96 m) Boostlite® Forestry Hose, Rocker lug fittings, NPSH thread.....	1,518.00
FRSTI-200-NST	1" (25 mm) x 200' (60.96 m) Boostlite® Forestry Hose, Pin lug fittings, NST thread.....	1,572.00
FRSTI-200-NST-RL	1" (25 mm) x 200' (60.96 m) Boostlite® Forestry Hose, Rocker lug fittings, NST thread.....	1,518.00
<i>See Pages 5, 6, 13 or 14 for recommended nozzle options</i>		

**Electric Rewind Hydraulic Reels**

**Compact Electric Rewind Hydraulic Reels**

ERWH-10-16	Compact Electric Rewind Hydraulic Reel.....	2,191.00
Compact reels include Rear Mount Motor, SCS Speed Control, and affixed Guide Rollers as standards that cannot be modified		

**Electric Rewind Hydraulic Reels**

ERWH-15-10	Electric Rewind Cord Reel - Side Mount.....	1,400.00
ERWH-15-10-RL	Electric Rewind Cord Reel - Rear Mount.....	1,435.00
ERWH-16-6	Compact Electric Rewind Hydraulic Reel - Side Mount.....	1,400.00
ERWH-16-6-RL	Electric Rewind Hydraulic Reel - Rear Mount.....	1,435.00
<b>Additional Charge for:</b>		
ERW-GR	Guide Rollers Low - Mounting Horizontal on Shelf.....	130.00
ERW-GR-V45	Guide Roller High 45° - Mounting Vertical on Wall or Upside Down.....	130.00
ERW-GR-V90	Guide Roller High 90° - Mounting Vertical on Wall or Upside Down.....	130.00
ERW-GR-V0	0° Vertical Guide Roller.....	130.00
ERWC-GR-THRU	Thru Compartment Guide Rollers.....	131.00
HS-TWIN	Hose Stop for 1/4" (6.4 mm) Twin Line Hose.....	36.00
ERW-BRI	Brake for Reels with Hose.....	23.00
ERW-SCS	Speed Control.....	498.00
ERW-RMC	Rear Motor Mount Conversion Kit.....	197.00



Style	Description	US\$ List Price
<b><i>Hoses and Quick Disconnect Couplers for Hydraulic Reels</i></b>		
<b>H5-ORG-100</b>	Hydraulic Hose, Polythermal Twinline 5000 PSI (344.8 bar) Orange 100' (30.5 m).....	1,191.00
<b>H5-ORG-50</b>	Hydraulic Hose, Polythermal Twinline 5000 PSI (344.8 bar) Orange 50' (15.2 m).....	647.00
<b>H10-BLK-100</b>	Hydraulic Hose, Polythermal Twinline 10,000 PSI (690 bar) Black 100' (30.5 m).....	2,869.00
<b>H10-ORG-100</b>	Hydraulic Hose, Polythermal Twinline 10,000 PSI (690 bar) Orange 100' (30.5 m).....	2,869.00
<b>H10-BLK-8</b>	<b>(2 Required)</b> Hydraulic Lead-in Hose, Rubber 10,000 PSI (690 bar) Black 8' (2.4 m).....	78.00
<b>H10-BLK-12</b>	<b>(2 Required)</b> Hydraulic Lead-in Hose, Rubber 10,000 PSI (690 bar) Black 12' (3.7 m).....	91.00
<b><i>Hoses and Quick Disconnect Couplers for Hydraulic Reels</i></b>		
<b>H10P-BLK-16</b>	<b>(2 Required)</b> Hydraulic Hose, Polythermal Twinline 10,000 PSI (690 bar) Black 16' (4.9 m).....	324.00
<b>H10P-ORG-16</b>	<b>(2 Required)</b> Hydraulic Hose, Polythermal Twinline 10,000 PSI (690 bar) Orange 16' (4.9 m).....	324.00
<b>H10P-BLK-12</b>	<b>(2 Required)</b> Hydraulic Hose, Polythermal Twinline 10,000 PSI (690 bar) Black 12' (4.0 m).....	232.00
<b>H10P-ORG-12</b>	<b>(2 Required)</b> Hydraulic Hose, Polythermal Twinline 10,000 PSI (690 bar) Orange 12' (4.0 m).....	232.00
<b>H10P-BLK-8</b>	<b>(2 Required)</b> Hydraulic Hose, Polythermal Twinline 10,000 PSI (690 bar) Black 8' (2.4 m).....	178.00
<b>H10P-ORG-8</b>	<b>(2 Required)</b> Hydraulic Hose, Polythermal Twinline 10,000 PSI (690 bar) Orange 8' (2.4 m).....	178.00
<i>Quick Disconnects Available for Hurst, Amkus, Genisis, TNT &amp; Phoenix Rescue Tools</i>		
*Other colors available: Red, Blue, Yellow and Green; call customer service for detailed pricing		
<b><i>Electric Rewind Air Reels</i></b>		
<b><i>Compact Electric Rewind Air Reels</i></b>		
<b>ERWU-10-16</b>	Low Profile Electric Rewind Utility Air Reel.....	2,191.00
<b>ERWA-10-16</b>	Low Profile Electric Rewind High pressure Breathing Air Reel.....	2,191.00
Compact reels include Rear Mount Motor, SCS Speed Control, and affixed Guide Rollers as standards that cannot be modified		
<b>ERWU-15-10</b>	Electric Rewind Utility Air - Side Mount.....	971.00
<b>ERWU-15-10-RM</b>	Electric Rewind Utility Air - Rear Mount.....	1,097.00
<b>ERWA-15-10</b>	High Pressure Breathing Air - Side Mount.....	1,480.00
<b>ERWA-15-10-RM</b>	High Pressure Breathing Air - Rear Mount.....	1,607.00
<b><i>Additional Charge for:</i></b>		
<b>ERW-GR</b>	Guide Rollers Low - Mounting Horizontal on Shelf.....	130.00
<b>ERW-GR-V45</b>	Guide Roller High 45° - Mounting Vertical on Wall or Upside Down.....	130.00
<b>ERW-GR-V90</b>	Guide Roller High 90° - Mounting Vertical on Wall or Upside Down.....	130.00
<b>ERWC-GR-THRU</b>	Thru Compartment Guide Rollers.....	131.00
<b>HS-BA</b>	Hose Stop for Breathing Air Hose.....	27.00
<b>HS-TOOL</b>	Hose Stop for Utility Air Hose.....	27.00
<b>ERW-BR1</b>	Brake for Reels with Hose.....	23.00
<b>ERW-SCS</b>	Speed Control.....	498.00
<b>ERW-RMC</b>	Rear Motor Mount Conversion Kit.....	197.00

Style	Description	US\$ List Price
<b><i>Hose for Utility Air Reels</i></b>		
<b>UA-100</b>	100 ft., 3/8" i.d., 1/4" male NPT fittings.....	181.00
<b>UA-150</b>	150 ft., 3/8" i.d., 1/4" male NPT fittings.....	249.00
<b>UA-200</b>	200 ft., 3/8" i.d., 1/4" male NPT fittings.....	332.00
<b>UA-150-1/2</b>	150 ft., 1/2" i.d., 3/8" & 1/4" male NPT fittings.....	340.00
<b>UA-200-1/2</b>	200 ft., 1/2" i.d., 3/8" & 1/4" male NPT fittings.....	441.00
<b><i>Manual Non-Live Cord Reels</i></b>		
<b>NCRP-10</b>	10" (254 mm) Non-Live Cord Reel.....	189.00
<b>NCRP-15</b>	15" (381 mm) Non-Live Cord Reel.....	207.00
<b>NCRP-18</b>	18" (457 mm) Non-Live Cord Reel.....	228.00
<i>See Page 39 for Seoprene Cord Options</i>		
<i>See Page 43 for Plug, Connector and Receptacle Options</i>		
<b><i>Manual Live Cord Reels</i></b>		
<b>ECRP-10</b>	10" (254 mm) Live Cord Reel.....	268.00
<b>ECRP-15</b>	15" (381 mm) Live Cord Reel.....	286.00
<b>ECRP-18</b>	18" (457 mm) Live Cord Reel.....	307.00
<i>See Page 39 for Seoprene Cord Options</i>		
<i>See Page 43 for Plug, Connector and Receptacle Options</i>		
<b><i>Manual Cord Reel Options</i></b>		
<b>LH</b>	L-Hooks (for non-live reels only).....	19.00
<b>GB</b>	Electrical Gang Box (specify receptacle).....	70.00
<b>ECR-MT</b>	3-Piece Cord Reel Mount.....	52.00
<b><i>Manual Cord Reel Lights</i></b>		
<b>ECRP-10-ELBE-500</b>	10" (254 mm) Live Cord Reel with Beta 500 Light and Gang Box.....	754.00
<b>ECRP-10-ELBE-750</b>	10" (254 mm) Live Cord Reel with Beta 750 Light and Gang Box.....	798.00
<b>ECRP-10-ELSS-XLAC</b>	10" (254 mm) Live Cord Reel with SceneStar™ 20000 lumen Light and Gang Box.....	1,996.00
<b>ECRP-15-ELBE-500</b>	15" (381 mm) Live Cord Reel with Beta 500 Light and Gang Box.....	772.00
<b>ECRP-15-ELBE-750</b>	15" (381 mm) Live Cord Reel with Beta 750 Light and Gang Box.....	816.00
<b>ECRP-15-ELSS-XLAC</b>	15" (381 mm) Live Cord Reel with SceneStar™ 20000 lumen Light and Gang Bo.....	2,014.00
<b>ECRP-18-ELBE-500</b>	18" (457 mm) Live Cord Reel with Beta 500 Light and Gang Box.....	793.00
<b>ECRP-18-ELBE-750</b>	18" (457 mm) Live Cord Reel with Beta 750 Light and Gang Box.....	837.00
<b>ECRP-18-ELSS-XLAC</b>	18" (457 mm) Live Cord Reel with SceneStar™ 20000 lumen Light and Gang Box.....	2,035.00
<i>See Page 39 for Seoprene Cord Options</i>		
<i>See Page 43 for Plug, Connector and Receptacle Options</i>		

Style	Description	US\$ List Price
<b>Electric Rewind Cord Reels</b>		
<i>Compact Electric Rewind Cord Reels</i>		
<b>ERWC-10-16</b>	Compact Electric Rewind Cord Reel.....	1,942.00
<b>ERWC-10-28</b>	Compact Electric Rewind Cord Reel.....	2,067.00
Compact reels include Rear Mount Motor, SCS Speed Control, and affixed Guide Rollers as standards that cannot be modified		
<i>Electric Rewind Cord Reels</i>		
<b>ERWC-15-10</b>	Electric Rewind Cord Reel - Side Mount .....	1,364.00
<b>ERWC-15-10-RM</b>	Electric Rewind Cord Reel - Rear Mount.....	1,477.00
<b>ERWC-16-6</b>	Electric Rewind Cord Reel - Side Mount .....	1,321.00
<b>ERWC-16-6-RM</b>	Electric Rewind Cord Reel - Rear Mount.....	1,446.00
<b>Additional Charge for:</b>		
<b>ERWC-GR</b>	Guide Rollers.....	131.00
<b>ERWC-GR-6</b>	Guide Rollers for ERWC-16-6 .....	131.00
<b>ERWC-GR-6-V45</b>	45° Guide Rollers for ERWC-16-6 .....	131.00
<b>ERWC-GR-6-V90</b>	90° Guide Rollers for ERWC-16-6.....	131.00
<b>ERWC-GR-6-V0</b>	0° Guide Rollers for ERWC-16-6 .....	131.00
<b>ERWC-GR-V45</b>	45° Guide Rollers.....	131.00
<b>ERWC-GR-V90</b>	90° Guide Rollers .....	131.00
<b>ERWC-GR-V0</b>	0° Vertical Guide Roller .....	131.00
<b>ERWC-GR-THRU</b>	Thru Compartment Guide Rollers.....	131.00
<b>CS-08</b>	Cord Ball Stop for 8 Gauge Wire.....	27.00
<b>CS-10</b>	Cord Ball Stop for 10 Gauge Wire.....	27.00
<b>CS-12</b>	Cord Ball Stop for 12 Gauge Wire.....	27.00
<b>ERWC-RMC</b>	Rear Mount Conversion Kit.....	198.00

**Seoprene 105 - Black Cord (priced by the foot)**

<b>163B300</b>	16/3 Cord, 300V .....	1.35
<b>143B300</b>	14/3 Cord, 300V.....	1.60
<b>123B300</b>	12/3 Cord, 300V.....	2.45
<b>103B300</b>	10/3 Cord, 300V .....	3.64
<b>143B600</b>	14/3 Cord, 600V .....	3.09
<b>123B600</b>	12/3 Cord, 600V .....	2.60
<b>103B600</b>	10/3 Cord, 600V .....	3.69
<b>104B600</b>	10/4 Cord, 600V.....	4.41
<b>083B600</b>	8/3 Cord, 600V .....	5.87
<b>084B600</b>	8/4 Cord, 600V .....	5.97

See Page 43 for Plug and Connector Options

**Seoprene 105 - Yellow Cord (priced by the foot)**

<b>143Y300</b>	14/3 Cord, 300V.....	2.88
<b>123Y300</b>	12/3 Cord, 300V.....	2.96
<b>103Y300</b>	10/3 Cord, 300V .....	4.41
<b>143Y600</b>	14/3 Cord, 600V .....	3.70
<b>123Y600</b>	12/3 Cord, 600V .....	4.63
<b>103Y600</b>	10/3 Cord, 600V.....	4.63
<b>104Y600</b>	10/4 Cord, 600V .....	5.56
<b>083Y600</b>	8/3 Cord, 600V .....	12.10
<b>084Y600</b>	8/4 Cord, 600V .....	12.17

See Page 43 for Plug and Connector Options

**25' Cord Sets with 5-15 15 Amp/125V Straight Blade Plugs and Connectors**

<b>143B325-5-15</b>	25' (7.6 m) 14-3 300V with 5-15 Plug and Connector.....	70.85
<b>143Y325-5-15</b>	25' (7.6 m) 14-3 300V with 5-15 Plug and Connector.....	102.45
<b>123B325-5-15</b>	25' (7.6 m) 12-3 300V with 5-15 Plug and Connector .....	91.92
<b>123Y325-5-15</b>	25' (7.6 m) 12-3 300V with 5-15 Plug and Connector .....	105.10

Style	Description	US\$ List Price
<b>25' Cord Sets with L5-15 15 Amp/125V Twist Lock Plugs and Connectors</b>		
<b>143B325-L5-15</b>	14-3 300V, with L5-15 Plug and Connector .....	73.48
<b>143Y325-L5-15</b>	14-3 300V, with L5-15 Plug and Connector .....	105.45
<b>123B325-L5-15</b>	12-3 300V, with L5-15 Plug and Connector.....	94.88
<b>123Y325-L5-15</b>	12-3 300V, with L5-15 Plug and Connector.....	108.07
<b>25' Cord Sets with L5-20 20 Amp/125V Twist Lock Plugs and Connectors</b>		
<b>123B325-L5-20</b>	12-3 300V, with L5-20 Plug and Connector .....	99.50
<b>123Y325-L5-20</b>	12-3 300V, with L5-20 Plug and Connector .....	112.33
<b>50' Cord Sets with 5-15 15 Amp/125V Straight Blade Plugs and Connectors</b>		
<b>143B350-5-15</b>	50' (15.2 m) 14-3 300V with 5-15 Plug and Connector .....	115.64
<b>143Y350-5-15</b>	50' (15.2 m) 14-3 300V with 5-15 Plug and Connector .....	182.83
<b>123B350-5-15</b>	50' (15.2 m) 12-3 300V with 5-15 Plug and Connector.....	159.34
<b>123Y350-5-15</b>	50' (15.2 m) 12-3 300V with 5-15 Plug and Connector.....	188.14
<b>50' Cord Sets with L5-15 15 Amp/125V Twist Lock Plugs and Connectors</b>		
<b>143B350-L5-15</b>	14-3 300V, with L5-15 Plug and Connector .....	118.58
<b>143Y350-L5-15</b>	14-3 300V, with L5-15 Plug and Connector .....	185.79
<b>123B350-L5-15</b>	12-3 300V, with L5-15 Plug and Connector.....	163.40
<b>123Y350-L5-15</b>	12-3 300V, with L5-15 Plug and Connector.....	191.05
<b>50' Cord Sets with L5-20 20 Amp/125V Twist Lock Plugs and Connectors</b>		
<b>123B350-L5-20</b>	12-3 300V, with L5-20 Plug and Connector .....	168.01
<b>123Y350-L5-20</b>	12-3 300V, with L5-20 Plug and Connector .....	191.05
<b>100' Cord Sets with 5-15 15 Amp/125V Straight Blade Plugs and Connectors</b>		
<b>143B3100-5-15</b>	14-3 300V, with 5-15 Plug and Connector.....	197.98
<b>143Y3100-5-15</b>	14-3 300V, with 5-15 Plug and Connector.....	332.35
<b>123B3100-5-15</b>	12-3 300V, with 5-15 Plug and Connector.....	287.57
<b>123Y3100-5-15</b>	12-3 300V, with 5-15 Plug and Connector.....	342.90
<b>100' Cord Sets with L5-15 15 Amp/125V Twist Lock Plugs and Connectors</b>		
<b>143B3100-L5-15</b>	14-3 300V, with L5-15 Plug and Connector .....	200.92
<b>143Y3100-L5-15</b>	14-3 300V, with L5-15 Plug and Connector .....	335.32
<b>123B3100-L5-15</b>	12-3 300V, with L5-15 Plug and Connector.....	290.52
<b>123Y3100-L5-15</b>	12-3 300V, with L5-15 Plug and Connector.....	345.86
<b>100' Cord Sets with L5-20 20 Amp/125V Twist Lock Plugs and Connectors</b>		
<b>123B3100-L5-20</b>	12-3 300V, with L5-20 Plug and Connector .....	295.14
<b>123Y3100-L5-20</b>	12-3 300V, with L5-20 Plug and Connector .....	350.47

Style	Description	US\$ List Price
<b>FirePower Connector Extension Cord Sets (Various Lengths)</b>		
<b>FPC-163B600-3EX</b>	3' (.91m) 16-3 600V cable, with FirePower Connections.....	322.17
<b>FPC-123Y600-3EX</b>	3' (.91m) 12-3 600V cable, with FirePower Connections.....	354.14
<b>FPC-103Y600-3EX</b>	3' (.91m) 10-3 600V cable, with FirePower Connections.....	434.57
<b>FPC-123Y600-10EX</b>	10' (3m) 12-3 600V cable, with FirePower Connections.....	389.48
<b>FPC-123Y600-25EX</b>	25' (7.5m) 12-3 600V cable, with FirePower Connections.....	475.41
<b>FPC-123Y600-30EX</b>	30' (9m) 12-3 600V cable, with FirePower Connections.....	527.00
<b>FPC-103Y600-100EX</b>	100' (30m) 10-3 600V cable, with FirePower Connections.....	1,174.29
<b>FPC-123Y600-150EX</b>	150' (45m) 12-3 600V cable, with FirePower Connections.....	1,080.00
<b>FPC-123Y600-200EX</b>	200' (60m) 12-3 600V cable, with FirePower Connections.....	1,363.00
<b>FPC-103Y600-200EX</b>	200' (60m) 10-3 600V cable, with FirePower Connections.....	1,894.29

**Gang Boxes**

<b>GB-1</b>	Single Gang Box with 5-15 or 5-20 Duplex Receptacles.....	75.14
<b>GB-1-GFI</b>	Single Gang Box with GFCI Duplex Receptacle.....	80.23
<b>GB-2</b>	Double Gang Box with Two 15 or 20 amp Receptacles.....	138.78
<b>GB-2L</b>	Double Gang Box with Two Twist Lock Plugs.....	138.78
<b>GB-2-4W</b>	Double Gang Box Wired 4 Wire.....	138.78
<b>GB-2-GFI</b>	Double Gang Box with GFCI Receptacle.....	213.89

**Pigtails**

<b>PG-1</b>	1' (.3 m) Pigtail with 5-15 Plug and L5-15 Connector.....	36.91
<b>PG-1Y</b>	1' (.3 m) Pigtail with 5-15 Plug and L5-15 Connector.....	37.59
<b>PG-3</b>	1' (.3 m) Pigtail with L5-15 Plug and 5-15 Connector.....	37.58
<b>PG-3Y</b>	1' (.3 m) Pigtail with L5-15 Plug and 5-15 Connector.....	38.25
<b>PG-5</b>	1' (.3 m) Pigtail with L5-20 Plug and 5-15 Connector.....	39.55
<b>PG-5Y</b>	1' (.3 m) Pigtail with L5-20 Plug and 5-15 Connector.....	39.88
<b>PG-6</b>	1' (.3 m) Pigtail with L5-20 Plug and L5-15 Connector.....	40.54
<b>PG-6Y</b>	1' (.3 m) Pigtail with L5-20 Plug and L5-15 Connector.....	48.79
<b>PG-7</b>	1' (.3 m) Pigtail with L5-30 Plug and 5-15 Connector.....	49.44
<b>PG-7Y</b>	1' (.3 m) Pigtail with L5-30 Plug and 5-15 Connector.....	50.10
<b>PG-9</b>	1' (.3 m) Pigtail with 5-20 Plug and 5-15 Connector.....	48.12
<b>PG-9Y</b>	1' (.3 m) Pigtail with 5-20 Plug and 5-15 Connector.....	48.44
<b>PG-10</b>	1' (.3 m) Pigtail with L5-30 Plug and 5-20 Connector.....	67.88
<b>PG-10Y</b>	1' (.3 m) Pigtail with L5-30 Plug and 5-20 Connector.....	68.54
<b>PG-12</b>	1' (.3 m) Pigtail with L5-20 Plug and 5-20 Connector.....	58.01
<b>PG-12Y</b>	1' (.3 m) Pigtail with L5-20 Plug and 5-20 Connector.....	58.65
<b>PG-13</b>	1' (.3 m) Pigtail with 5-20 Plug and L5-15 Connector.....	49.11
<b>PG-13Y</b>	1' (.3 m) Pigtail with 5-20 Plug and L5-15 Connector.....	49.76
<b>PG-14</b>	1' (.3 m) Pigtail with L5-30 Plug and L5-15 Connector.....	50.42
<b>PG-14Y</b>	1' (.3 m) Pigtail with L5-30 Plug and L5-15 Connector.....	51.07
<b>PG-15</b>	1' (.3 m) Pigtail with 5-20 Plug and L5-20 Connector.....	52.07
<b>PG-15Y</b>	1' (.3 m) Pigtail with 5-20 Plug and L5-20 Connector.....	52.74
<b>PG-17</b>	1' (.3 m) Pigtail with L5-30 Plug and L5-20 Connector.....	53.37
<b>PG-17Y</b>	1' (.3 m) Pigtail with L5-30 Plug and L5-20 Connector.....	54.05

Style	Description	US\$ List Price
<b>Electrical Junction Box</b>		
<b>EJBX</b>	Electrical Junction Box (Standard Color is Gray).....	510.00
<i>See Pages 42-43 for Plug, Connector and Receptacle Options</i>		
<b>Additional Junction Box Options</b>		
<b>EJB-GFI</b>	GFCI Household Duplex Receptacle.....	81.00
<b>EJB-RF</b>	Rubber Feet (set of 4).....	22.00
<b>EJB-PP</b>	Powder Coated Box (Black, White, Yellow, or Red).....	39.00
<b>BK-1</b>	First Circuit Breaker with Weatherproof Cover.....	124.00
<b>BK-2</b>	Second Circuit Breaker with Weatherproof Cover.....	72.00
<b>BK-3</b>	Third Circuit Breaker with Weatherproof Cover.....	72.00
<b>BK-4</b>	Fourth Circuit Breaker with Weatherproof Cover.....	72.00
<b>L34-CG</b>	1' (.3 m) Pigtail with Wire Mesh Cord Grip.....	100.00
<b>L-5-30 or L6-30</b>		
	3-wire, 30amp Plug, Receptacles, or Recessed Inlet.....	21.00
<b>L14-20</b>	4-wire, 20amp Plug, Receptacles, or Recessed Inlet.....	22.00
<b>L14-30</b>	4-wire, 30amp Plug, Receptacles, or Recessed Inlet.....	72.00
<b>EJB-PP-RC</b>	Powder Painting of a Receptacle Cover.....	145.00
<i>See Page 41 for Junction Box Order Form</i>		
<i>See Page 42-43 for Plug and Connector Options</i>		
<b>Junction Box Mounting Brackets and Accessories</b>		
<b>EJB-MT</b>	Mounting Bracket.....	101.00
<b>EJB-HMT-TP</b>	Horizontal Mount (Treadplate).....	247.00
<b>EJB-VMT-TP</b>	Vertical Mount (Treadplate).....	247.00
<b>EJB-HMT</b>	Horizontal Mount.....	247.00
<b>EJB-VMT</b>	Vertical Mount.....	247.00
<b>EL-HANGER</b>	Hanger Strap for Junction Box.....	45.00
<b>EJB-PP-MT</b>	Powder Painting of any Mount (except Treadplate [TP], Gray exempted).....	39.00

**Rapid Fill System**

<b>ARFS-500500</b>	Akron Rapid Fill Foam System.....	976.00
<i>Includes Pump, Wire Harness with Panel and Tank Switches, Panel Connection Hardware, 4 foot Pickup Tube with Stinger and 7.5 feet of Hose with Hose Connection Hardware</i>		
<b>500-PVC</b>	Additional Hose (price per foot).....	4.00

# Junction Box Order Form

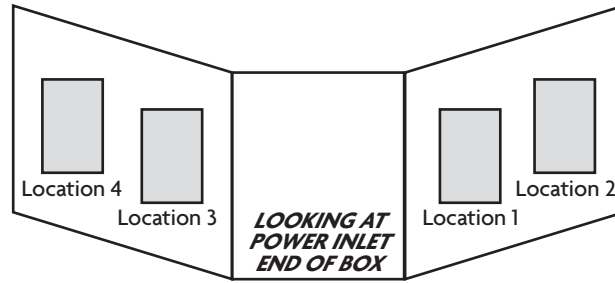

**A)** Specify the NEMA configuration of each receptacle by the “Location” number. See the back of this sheet for configurations:

Location 1 \_\_\_\_\_

Location 2 \_\_\_\_\_

Location 3 \_\_\_\_\_

Location 4 \_\_\_\_\_

**A dual voltage Junction Box that has both 120 volt and 240 volt receptacles will always have four wires exiting the box. If a recessed flange inlet is desired instead of direct wiring please specify which four connector inlet you desire.**

**B)** What “POWER INLET” configuration do you desire, **THE AMPERAGE OF YOUR POWER INLET DEVICE MUST BE THE SAME SIZE OR GREATER THAN THE SINGLE HIGHEST AMPERAGE RECEPTACLE:**

12” pigtail with strain relief and plug. Specify the plug’s NEMA configuration number. Select from the back of this sheet. # \_\_\_\_\_

Recessed flanged inlet plug. Specify the inlet’s NEMA configuration number. Select from the back of this sheet. # \_\_\_\_\_

Strain relief with bare wires exiting Junction Box. Ready for direct wiring to cord set and/or cord reel.

**All plugs, connectors, receptacles and recessed flanged inlets must be UL Listed and grounded for your protection.**

## OPTIONAL ITEMS: Refer to current price sheet for additional pricing.

- EJB-GFI Household duplex receptacle. (Note: The GFCI receptacle will be wired first making all down stream receptacles being GFCI protected, or the GFCI can be wired last making it the only GFCI protected receptacle.)
- EJB-MT Apparatus mounting bracket set. A tapered mounting boss is located on one end of the box which fits into a PLMT spring loaded retaining bracket.
- EJB-VMT Vertical apparatus mounting bracket; specify powder painted aluminum or aluminum treadplate.
- EJB-HMT Horizontal apparatus mounting bracket; specify powder painted aluminum or aluminum treadplate.
- EJB-RF Four black rubber feet on bottom of The Junction Box.
- EJB-PP Powder painting The Junction Box; specify Yellow, Red, White or Black.
- BK-1-2-3-4 Circuit breakers with weatherproof snap cover; specify 15 or 20 amp. (Not available with EJB-MT).
- 134-CG One foot pigtail with a wire mesh cord grip; replaces standard strain relief.
- L5-30 or L6-30 3-wire, 30 ampere plug, receptacle or recessed inlet.
- L14-30 or L14-20 4-wire, 20 or 30 ampere plug, receptacle or recessed inlet.

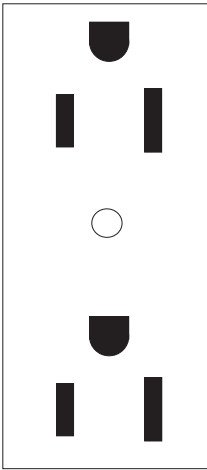

5-15  
DUPLEX  
15A - 125 Volt  
Straight Blade  
**#2**

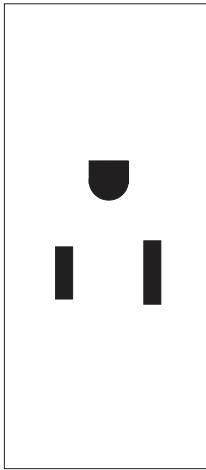

5-15  
SINGLE  
15A - 125 Volt  
Straight Blade  
**#3**

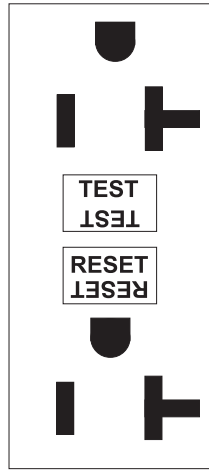

5-20 - **GFCI**  
DUPLEX  
20A - 125 Volt  
Straight Blade  
**#4**

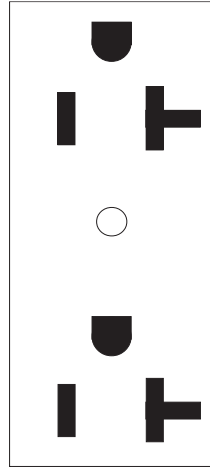

5-20  
DUPLEX  
20A - 125 Volt  
Straight Blade  
**#5**

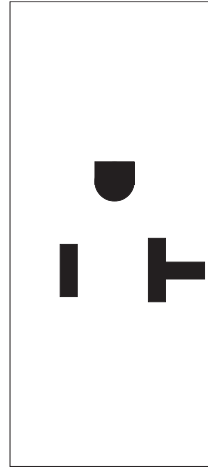

5-20  
SINGLE  
20A - 125 Volt  
Straight Blade  
**#6**

Numbers out of sequence because three NEMA configurations were never used.

Numbers Deleted:  
**#1, #14 & #16**

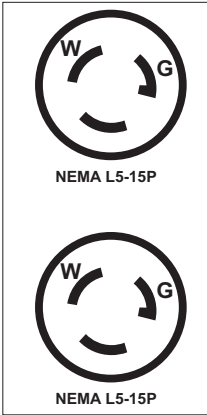

L5-15  
DUPLEX  
15A - 125 Volt  
Twist Lock  
**#7**

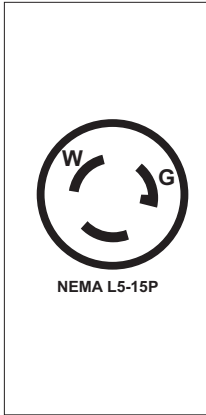

L5-15  
SINGLE  
15A - 125 Volt  
Twist Lock  
**#8**

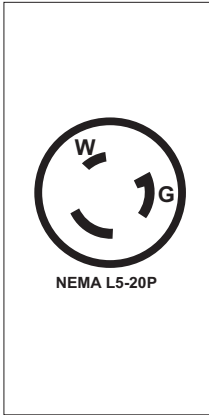

L5-20  
SINGLE  
20A - 125 Volt  
Twist Lock  
**#9**

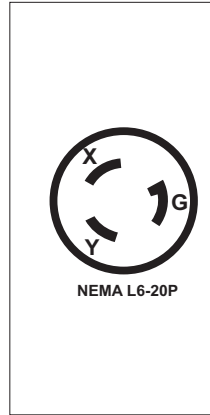

L6-20  
SINGLE  
20A - 250 Volt  
Twist Lock  
**#10**

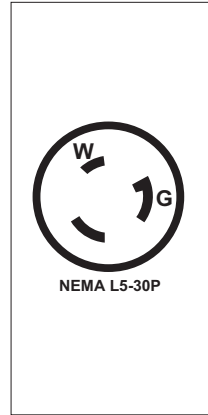

L5-30  
SINGLE  
30A - 125 Volt  
Twist Lock  
(optional)  
**#11**

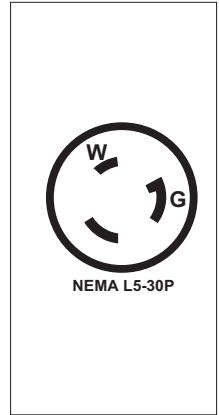

L6-30  
SINGLE  
30A - 250 Volt  
Twist Lock  
(optional)  
**#12**

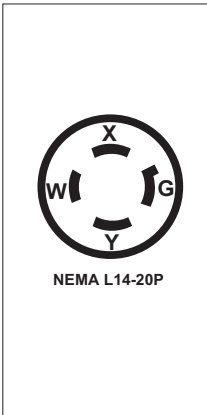

L14-20  
SINGLE  
20A - 125/250 Volt  
Twist Lock  
4 - WIRE  
(optional)  
**#13**

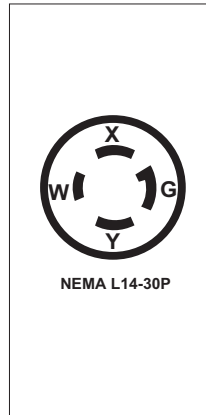

L14-30  
SINGLE  
30A - 125/250 Volt  
Twist Lock  
4 - WIRE  
(optional)  
**#15**











**Akron Brass Co. uses Pass & Seymour plugs, connectors, receptacles and recessed inlets as its standard.**

**If you require a specific brand (e.g., Hubbell) please contact customer service for product pricing and availability.**



## Plugs & Connectors

UL and CSA listed, **EXTENDA-LITE®** uses high quality PASS & SEYMOUR plugs and connectors. Featuring impact resistant, ribbed nylon housing with integral cord grips. Plugs and connectors can withstand pull tests in excess of 150 pounds and extra hard use. All plugs and connectors come in safety yellow, and have a UL electrical temperature index of 257°F (125°C).

	P/N	EJB Order Form #	Description		US\$ List Price
 NEMA 5-15P	202-PG	#3	Household Plug	15 AMP, 125 Volt	11.16
	212-CN	N/A	Household Connector	15 AMP, 125 Volt	20.74
	222-R	#3	Household Single Receptacle	15 AMP, 125 Volt	12.61
	222-R/D	#2	Household Duplex Receptacle	15 AMP, 125 Volt	11.16
	232-FI	#3	Household Flanged Inlet Plug	15 AMP, 125 Volt	13.76
 NEMA 5-20P	209-PG	#6	Household Plug	20 AMP, 125 Volt	22.94
	219-CN	N/A	Household Connector	20 AMP, 125 Volt	38.68
	229-R	#6	Household Single Receptacle	20 AMP, 125 Volt	14.25
	229-R/D	#5 *	Household Duplex Receptacle	20 AMP, 125 Volt	15.06
	239-FI	#6	Household Flanged Inlet Plug	20 AMP, 125 Volt	26.35
 NEMA L5-15P	203-PG	#8	Twist Lock Plug	15 AMP, 125 Volt	13.04
	213-CN	N/A	Twist Lock Connector	15 AMP, 125 Volt	21.81
	223-R	#8	Twist Lock Single Receptacle	15 AMP, 125 Volt	18.16
	223-R/D	#7	Twist Lock Duplex Receptacle	15 AMP, 125 Volt	28.95
	233-FI	#8	Twist Lock Flanged Inlet Plug	15 AMP, 125 Volt	20.34
 NEMA L5-20P	204-PG	#9	Twist Lock Plug	20 AMP, 125 Volt	14.57
	214-CN	N/A	Twist Lock Connector	20 AMP, 125 Volt	24.80
	224-R	#9	Twist Lock Single Receptacle	20 AMP, 125 Volt	17.82
	234-FI	#9	Twist Lock Flanged Inlet Plug	20 AMP, 125 Volt	18.55
 NEMA L6-20P	205-PG	#10	Twist Lock Plug	20 AMP, 250 Volt	17.27
	215-CN	N/A	Twist Lock Connector	20 AMP, 250 Volt	27.00
	225-R	#10	Twist Lock Single Receptacle	20 AMP, 250 Volt	22.13
	235-FI	#10	Twist Lock Flanged Inlet Plug	20 AMP, 250 Volt	20.34
 NEMA L5-30P	208-PG	#11	Twist Lock Plug	30 AMP, 125 Volt	25.36
	218-CN	N/A	Twist Lock Connector	30 AMP, 125 Volt	53.55
	228-R	#11	Twist Lock Single Receptacle	30 AMP, 125 Volt	31.95
	238-FI	#11	Twist Lock Flanged Inlet Plug	30 AMP, 125 Volt	36.26
 NEMA L6-30P	206-PG	#12	Twist Lock Plug	30 AMP, 250 Volt	25.36
	216-CN	N/A	Twist Lock Connector	30 AMP, 250 Volt	53.55
	226-R	#12	Twist Lock Single Receptacle	30 AMP, 250 Volt	31.95
	236-FI	#12	Twist Lock Flanged Inlet Plug	30 AMP, 250 Volt	36.26
 NEMA L14-20P	701-PG	#13	Twist Lock Plug	20 AMP, 125/250 Volt	25.37
	711-CN	N/A	Twist Lock Connector	20 AMP, 125/250 Volt	52.91
	721-R	#13	Twist Lock Single Receptacle	20 AMP, 125/250 Volt	29.35
	731-FI	#13	Twist Lock Flanged Inlet Plug	20 AMP, 125/250 Volt	31.88
 NEMA L14-30P	703-PG	#15	Twist Lock Plug	30 AMP, 125/250 Volt	33.49
	713-CN	N/A	Twist Lock Connector	30 AMP, 125/250 Volt	69.47
	723-R	#15	Twist Lock Single Receptacle	30 AMP, 125/250 Volt	51.52
	733-FI	#15	Twist Lock Flanged Inlet Plug	30 AMP, 125/250 Volt	64.65
 Weatherproof Plug & Connector Covers	150-RB	N/A	15 AMP Connector Boot	15 AMP	17.66
	151-RB	N/A	15 AMP Plug Boot	15 AMP	15.62
	152-RB	N/A	20/30 AMP Connector Boot	20/30 AMP	17.66
	153-RB	N/A	20/30 AMP Plug Boot	20/30 AMP	15.62

Call for pricing on any plug, connector, receptacle or flanged inlet configuration not listed above.

\* #4 GFCI Duplex 20 AMP, 125 Volt Straight Blade





# WELDON

A DIVISION OF AKRON BRASS

---

## List Price Guide

Effective: January 5, 2015

All Prices in U.S. Dollars.

(Prices are for U.S. domestic resale and do not include International Tariffs, Taxes and Shipping.)

Supersedes All Previous Prices

## WELDON STANDARD TERMS AND CONDITIONS OF SALE

These Standard Terms and Conditions of Sale shall take precedence over any additional or conflicting provisions, terms, or conditions offered by Buyer or contained in any of Buyer's order forms except for instructions related to quantity or shipping of the goods. Any reference to "Supplier" herein shall mean Weldon, a division of Akron Brass Company.

- PAYMENT TERMS:** Net-balance payable 30 days from date of billing, or as established by Supplier's credit department. In the event shipments are less than whole lots, pro rata payments are due from Buyer as shipments are made, and if shipments are delayed by Buyer said pro rata payments are due on the date when the Supplier is ready to ship. Prices quoted do not include taxes.
- CANCELLATIONS:** Supplier will assess a 25% cancellation fee or \$100.00 cancellation charge; whichever is greater, to any and all cancelled orders of Supplier's standard goods that are cancelled within thirty (30) days of the scheduled ship date. Custom or proprietary goods carry a 100% cancellation penalty if cancelled within thirty (30) days of the scheduled ship date. Buyer's cancellation notice to Supplier must be in the form of standard mail or facsimile to Supplier's main office in Columbus, Ohio. Supplier will then confirm the cancellation and the cancellation fee due from Buyer.
- FREIGHT:** The goods shall be delivered F.O.B. Supplier's Columbus, Ohio plant. Title to the goods shall pass to the Buyer at the time Supplier delivers the goods to a common carrier for shipment in accordance with Buyer's instructions. In recognition of the fact that shipping dates are approximate, Supplier's liability shall not extend to any loss or expense incurred by Buyer due to Supplier's production or other delays.
- RETURNS:** Supplier's Customer Service Department must authorize all returns in advance, with a Returned Goods Authorization (RGA) number assigned. Goods must be returned freight prepaid. Goods returned without a RGA number will not be accepted by Supplier's Receiving Department and will be shipped back to the original shipper at their expense. Non-warranty returns shall be assessed a 15% restocking fee; and goods may not be returned after one year from the original sale date. Weldon, A Division of Akron Brass, RGA#\_\_\_\_, 3656 Paragon Drive, Columbus, Ohio 43228.
- WARRANTY:** The Supplier warrants that for a minimum period of twenty-four (24) months from the date of manufacture, goods sold hereunder will be free from defects in materials and workmanship. Supplier produces multiple goods, some having warranty periods beyond twenty-four (24) months; please call the Customer Service Department to obtain the exact warranty length for specific goods. All warranty periods commence from the date the goods were manufactured. The sole and exclusive remedy of the Buyer for a breach of the Supplier's warranty hereunder shall be the repair or replacement, at the Supplier's option, of any defective or non-conforming goods. This warranty shall apply only where the Buyer has returned the goods under a RGA, shipping costs prepaid by the Buyer, along with a detailed written notice of the alleged defects or deficiencies within ninety (90) days after such defect or nonconformity is discovered. This warranty does not extend to any goods that are considered by Supplier to be consumable or wear goods, or to goods that have been subjected to abuse, misuse, neglect or accident, or to any goods that has been repaired or altered by other than the Supplier. THE WARRANTY SET FORTH IN THIS PARAGRAPH IS THE SOLE AND EXCLUSIVE WARRANTY AND IS IN LIEU OF ALL OTHER WARRANTIES, EXPRESS OR IMPLIED, INCLUDING ANY WARRANTIES OF MERCHANTABILITY, TITLE, OR FITNESS FOR A PARTICULAR PURPOSE.

THE SUPPLIER SHALL UNDER NO CIRCUMSTANCES BE LIABLE TO THE BUYER OR TO ANY THIRD PARTY FOR ANY CONSEQUENTIAL, INCIDENTAL, INDIRECT, PUNITIVE, OR SPECIAL DAMAGES, IRRESPECTIVE OF WHETHER THE ALLEGED BASIS FOR LIABILITY IS FOUNDED ON WARRANTY, CONTRACT, TORT, STATUTE, REGULATION, EQUITABLE CONSIDERATION OR ANY OTHER THEORY.

- INDEMNIFICATION:** The Supplier will indemnify, defend and otherwise hold harmless the Buyer from all cost, loss, damage or liability arising from any proceeding or claim brought or asserted against the Buyer to the extent such proceeding or claim is based on an allegation that the goods, as sold and delivered by the Supplier, infringe any patent, copyright, trademark or trade secret, provided the Buyer (i) promptly notifies the Supplier of any such proceeding or claim after it becomes known to the Buyer; and (ii) provides all the assistance and cooperation that the Supplier may reasonably request; and (iii) agrees that Supplier shall have sole control of the defense of any proceeding or claim. The Supplier shall not be liable to the Buyer under any provision of this paragraph to the extent that any claim is based upon: (1) a use for which the goods was not designated by the Supplier; or (2) an alteration of the goods by the Buyer or a third party which such alteration is the basis for the alleged infringement; or (3) any sale or use of an outmoded goods for which the Supplier offers non-infringing goods with the same functional characteristics or for use in the same applications. Further, should the Buyer be enjoined from using goods furnished by the Supplier because of an infringement, the Supplier shall at its own expense procure the right to continue using the goods or replace or modify the goods so that they become non infringing, or at the Supplier's option, refund to the Buyer the purchase price of such goods. The Supplier shall have no further liability to the Buyer for intellectual property infringement other than as expressly set forth in this paragraph.

The Buyer agrees to indemnify, defend and hold harmless the Supplier from and against any and all cost, loss, damage, injury, claims, liabilities, or demands (including the cost, expenses and reasonable attorney's fees on account thereof) which may be made against the Supplier which are alleged to arise out of or relate to: (i) any representation, warranty statement or covenant made by the Buyer to any person regarding the goods or any applications thereof in excess or derogation of those permitted hereunder, unless the Supplier expressly approves in writing such representation, warranty, statement or covenant; and (ii) any negligent or other wrongful act or omission of the Buyer and its agents; and (iii) any change made in the goods (or the Supplier provided documentation) by the Buyer without the Supplier's express written consent or Buyer's use of the goods in a manner or application for which the goods was not designed for by Supplier.

- FORCE MAJEURE:** Except for payment obligations, the consequences, direct or indirect, of labor troubles, fires, accidents, floods, war, shortage or transportation failure, suspension or curtailment of production due to shortage or supply of raw materials or other economic factors, government acts or requirements and any and all like or different causes beyond the control of the parties hereto shall excuse performance by either party to the extent by which performance is prevented thereby. Supplier will advise Buyer of any such delays and will revise delivery schedules accordingly.
- EXPORT:** Goods purchased or received under these Standard Terms and Conditions of Sale may be subject to export control laws, restrictions, regulations and orders of the United States. Buyer agrees to comply with all applicable export laws, restrictions and regulations of the United States or foreign agencies or authorities, and shall not export, or transfer for the purpose of re-export, any product to any prohibited or embargoed country or to any denied, blocked, or designated person or entity as mentioned in any such United States or foreign law or regulation. Buyer represents and warrants that it is not on the Denied Persons, Specially Designated Nationals or Debarred Persons List and is not otherwise prohibited by law from purchasing the goods sold hereunder. Buyer shall be responsible to obtain any license to export, re-export or import as may be required.
- GOVERNING LAW:** These Standard Terms and Conditions of Sale shall be governed and construed in all respects in accordance with the laws of the State of Ohio and each party hereby submits to the non-exclusive jurisdiction of the courts of the State of Ohio. The provisions of the United Nations on Contracts for the International Sale of Goods ("CISG") and the Contracts (Rights of Third Parties) Act of 1999 are expressly excluded from this Agreement, if otherwise applicable.
- TERMINATION:** Supplier, in its sole discretion, may evaluate Buyer's financial condition and may cancel any order if in Supplier's judgment the Buyer would be unable to meet its obligation, unless the Buyer shall upon written notice immediately pay for all goods delivered or shall pay in advance for all goods not delivered in accordance with Supplier's discretion.
- SEVERABILITY:** The provisions of these Standard Terms and Conditions of Sale are severable. Should any court of competent jurisdiction hold any of these clauses to be unlawful, such holding shall not invalidate all of the clauses, but rather, the unlawful clause shall be severed and the remaining provisions shall be fully enforceable.
- MISCELLANEOUS:** These Standard Terms and Conditions of Sale is the entire agreement between the parties and supersedes all prior agreements, correspondence and understandings relating to the subject matter hereof. No failure by either party to take any action or assert any right hereunder shall be deemed to be a waiver of such right in the event of the continuation or repetition of the circumstances giving rise to such right. Any amendments to these Standard Terms and Conditions of Sale must be made in writing and signed by a duly authorized officer of the Supplier. The headings herein are for convenience only and shall not affect interpretation.

© 2014 Premier Farnell Corporation. All rights reserved. Akron and the Akron Logo are trademarks of Premier Farnell Corporation.



Part #	Description	AMP Draw		Std Cnt Qty	List Price - US Dollars
		12 V AMP	24 V AMP		
V26S	2X6 D Back Utility Lamp, White	0.46	.225	6	171.00
V26W-A	2X6 D Back Amber LEDs w/Amber Lens	0.31	0.165	6	161.00
V26W-B	2X6 D Back Blue LEDs w/Blue Lens	0.46	0.225	6	171.00
V26W-R	2X6 D Back Red LEDs w/Red Lens	0.31	0.165	6	161.00
V26W-C00B	2X6 D Back Blue LEDs w/Clear Lens, Clear Optics	0.46	0.225	6	171.00
V26W-C00R	2X6 D Back Red LEDs w/Clear Lens, Clear Optics	0.31	0.165	6	161.00
V26W-C00W	2X6 D Back White LEDs w/Clear Lens, Clear Optics	0.46	0.225	6	171.00
V26W-C10A	2X6 D Back Amber LEDs w/Clear Lens, Amber Optics	0.31	0.165	6	168.00
V26W-C10B	2X6 D Back Blue LEDs w/Clear Lens, Blue Optics	0.46	0.225	6	181.00
V26W-C10R	2X6 D Back Red LEDs w/Clear Lens, Red Optics	0.31	0.165	6	168.00
V26W-C0VRA	2X6 D Back, Red/Amber, Vert Split, Clear Optics	0.31	0.165	6	168.00
V26W-C0VRW	2X6 D Back, Red/White, Vert Split, Clear Optics	0.46	0.225	6	181.00
V26W-C1VRB	2X6 D Back, Red/Blue, Vert Split, Colored Optics	0.46	0.225	6	181.00
	D Back Connectorized lamp option, 4 pin sealed				add 12.00
Additional vertical color split options available in 2X6					
V34S	3X4 D Back Utility Lamp, White	0.6	0.225	6	171.00
V34W-A	3X4 D Back Amber LEDs w/Amber Lens	0.31	0.165	6	161.00
V34W-B	3X4 D Back Blue LEDs w/Blue Lens	0.46	0.225	6	171.00
V34W-R	3X4 D Back Red LEDs w/Red Lens	0.31	0.165	6	161.00
V34W-C00B	3X4 D Back Blue LEDs w/Clear Lens, Clear Optics	0.46	0.225	6	171.00
V34W-C00R	3X4 D Back Red LEDs w/Clear Lens, Clear Optics	0.31	0.165	6	161.00
V34W-C00W	3X4 D Back White LEDs w/Clear Lens, Clear Optics	0.46	0.225	6	171.00
V34W-C10A	3X4 D Back Amber LEDs w/Clear Lens, Amber Optics	0.31	0.165	6	168.00
V34W-C10B	3X4 D Back Blue LEDs w/Clear Lens, Blue Optics	0.46	0.225	6	181.00
V34W-C10R	3X4 D Back Red LEDs w/Clear Lens, Red Optics	0.31	0.165	6	168.00
V34W-C0HRA	3X4 D Back Red/Amber, Horz Split, Clear Optics	0.31	0.165	6	168.00
V34W-C0HRW	3X4 D Back Red/White, Horz Split, Clear Optics	0.46	0.225	6	168.00
	D Back Connectorized lamp option, 4 pin sealed				add 12.00
Additional horizontal color split options available in 3x4					
V37S	3X7 D Back Scene	0.82	0.45	6	250.00
V37W-A	3X7 D Back Amber LEDs w/Amber Lens	0.62	0.33	6	207.00
V37W-B	3X7 D Back Blue LEDs w/Blue Lens	0.92	0.45	6	233.00
V37W-R	3X7 D Back Red LEDs w/Red Lens	0.62	0.33	6	207.00
V37W-C00B	3X7 D Back Blue LEDs w/Clear Lens, Clear Optics	0.92	0.45	6	233.00
V37W-C00R	3X7 D Back Red LEDs w/Clear Lens, Clear Optics	0.62	0.33	6	207.00
V37W-C00W	3X7 D Back White LEDs w/Clear Lens, Clear Optics	0.92	0.45	6	233.00
V37W-C10A	3X7 D Back Amber LEDs w/Clear Lens, Amber Optics	0.62	0.33	6	217.00
V37W-C10B	3X7 D Back Blue LEDs w/Clear Lens, Blue Optics	0.92	0.45	6	243.00
V37W-C10R	3X7 D Back Red LEDs w/Clear Lens, Red Optics	0.62	0.33	6	217.00
V37W-C0HRA	3X7 D Back Red/Amber, Horz Split, Clear Optics	0.62	0.33	6	217.00
V37W-C0HRW	3X7 D Back Red/White, Horz Split, Clear Optics	0.92	0.45	6	243.00
V37W-C0HRW-0006	3X7 D Back Red/Scene, Horz Split, Clear Optics	0.50	0.26	6	243.00
V37W-C0VRA	3X7 D Back Red/Amber, Vert Split, Clear Optics	0.62	0.33	6	217.00
V37W-C0VRB	3X7 D Back Red/Blue, Vert Split, Clear Optics	0.92	0.45	6	243.00
V37W-C1HRA	3X7 D Back Red/Amber, Horz Split, Colored Optics	0.62	0.33	6	217.00
V37W-C1HRW	3X7 D Back Red/White, Horz Split, Colored Optics	0.92	0.45	6	243.00
	D Back Connectorized lamp option, 4 pin sealed				add 12.00
Additional color split options available in 3x7					
V46S	4X6 D Back Scene	0.82	0.45	6	250.00
V46W-A	4X6 D Back Amber LEDs w/Amber Lens	0.62	0.33	6	210.00
V46W-B	4X6 D Back Blue LEDs w/Blue Lens	0.92	0.45	6	235.00

\* Amp Draw is variable and application dependent  
 \*\* Refer to individual lamps



Part #	Description	AMP Draw		Std Cnt Qty	List Price - US Dollars
		12 V AMP	24 V AMP		
V46W-R	4X6 D Back Red LEDs w/Red Lens	0.62	0.33	6	210.00
V46W-C00B	4X6 D Back Blue LEDs w/Clear Lens, Clear Optics	0.92	0.45	6	235.00
V46W-C00R	4X6 D Back Red LEDs w/Clear Lens, Clear Optics	0.62	0.33	6	210.00
V46W-C00W	4X6 D Back White LEDs w/Clear Lens, Clear Optics	0.92	0.45	6	235.00
V46W-C10A	4X6 D Back Amber LEDs w/Clear Lens, Amber Optics	0.62	0.33	6	220.00
V46W-C10B	4X6 D Back Blue LEDs w/Clear Lens, Blue Optics	0.92	0.45	6	245.00
V46W-C10R	4X6 D Back Red LEDs w/Clear Lens, Red Optics	0.62	0.33	6	220.00
V46W-COHRW	4X6 D Back Red/White, Horz Split, Clear Optics	0.92	0.45	6	245.00
V46W-COHRW-0006	4X6 D Back Red/Scene, Horz Split, Clear Optics	0.50	0.26	6	245.00
V46W-C0VRA	4X6 D Back Red/Amber, Vert Split, Clear Optics	0.62	0.33	6	220.00
V46W-C0VRW	4X6 D Back Red/White, Vert Split, Clear Optics	0.92	0.45	6	245.00
V46W-CIHRB	4X6 D Back Red/Blue, Horz Split, Colored Optics	0.92	0.45	6	245.00
V46W-CIVRB	4X6 D Back Red/Blue, Vert Split, Colored Optics	0.92	0.45	6	245.00
	D Back Connectorized lamp option, 4 pin sealed				add 12.00
Additional color split options available in 4x6					
V79S	7X9 D Back Scene	1.84	0.96	6	464.00
V79W-A	7X9 D Back Amber LEDs w/Amber Lens	1.24	0.67	6	364.00
V79W-B	7X9 D Back Blue LEDs w/Blue Lens	1.84	0.96	6	412.00
V79W-R	7X9 D Back Red LEDs w/Red Lens	1.24	0.67	6	364.00
V79W-C00B	7X9 D Back Blue LEDs w/Clear Lens, Clear Optics	1.84	0.96	6	412.00
V79W-C00R	7X9 D Back Red LEDs w/Clear Lens, Clear Optics	1.24	0.67	6	364.00
V79W-C00W	7X9 D Back White LEDs w/Clear Lens, Clear Optics	1.84	0.96	6	412.00
V79W-C10A	7X9 D Back Amber LEDs w/Clear Lens, Amber Optics	1.24	0.67	6	381.00
V79W-C10B	7X9 D Back Blue LEDs w/Clear Lens, Blue Optics	1.84	0.96	6	431.00
V79W-C10R	7X9 D Back Red LEDs w/Clear Lens, Red Optics	1.24	0.67	6	381.00
V79W-COHR	7X9 D Back Red/Amber, Horz Split, Clear Optics	1.24	0.67	6	381.00
V79W-COHRW	7X9 D Back Red/White, Horz Split, Clear Optics	1.84	0.96	6	431.00
V79W-C0VAR	7X9 D Back Amber/Red, Vert Split, Clear Optics	1.24	0.67	6	381.00
V79W-C0VRW	7X9 D Back Red/White, Vert Split, Clear Optics	1.84	0.96	6	431.00
V79W-C0XRB	7X9 D Back Red/Blue, Cross Split, Clear Optics	1.84	0.96	6	431.00
V79W-CIHRA	7X9 D Back Red/Amber, Horz Split, Colored Optics	1.24	0.67	6	381.00
V79W-CIVRA	7X9 D Back Red/Amber, Vert Split, Colored Optics	1.24	0.67	6	381.00
V79W-CIVRB	7X9 D Back Red/Blue, Vert Split, Colored Optics	1.84	0.96	6	431.00
V79W-CIXRA	7X9 D Back Red/Amber, Cross Split, Colored Optics	1.24	0.67	6	381.00
	D Back Connectorized lamp option, 4 pin sealed				add 12.00
Additional color split options available in 7x9					
V3702-5935-00	D Back Light bar, 8 Lamp, R/R/SC/A/A/SC/R/R	**	**	1	3,075.44
V3702-6738-00	D Back Light bar, 9 Lamp, R/R/R/R/W/R/R/R/R	**	**	1	2,956.56
V3702-7434-00	D Back Light bar, 10 Lamp, R/R/R/R/W/W/R/R/R/R	**	**	1	3,348.74
V3713-8536-00	D Back Light bar, 16 Lamp, WRAP-AROUND, RED/WH	**	**	1	6,369.31
0B22-07563-00	Casting, Cast 3X7 Tri-Cluster			4	120.06
0B53-0333-00	4X6 Chrome Plated Bezel 4600 Series			6	20.22
0B53-1016-00	3X7 Chrome Plated Bezel 3800 Series			6	19.19
0B53-1125-00	7X9 Chrome Plated Bezel 7800 Series			6	25.22
0B61-1257-00	Case For Field Service Kit, V-MUX			1	96.08
0B80-2495-00	Chrome Bezel Kit for 2"X6" Diamondback			1	24.99
0B80-2334-00	Chrome Bezel Kit For 3"X4" Diamondback			1	24.51
0B80-2335-00	Chrome Bezel Kit For 3"X7" Diamondback			1	26.17
0B80-2336-00	Chrome Bezel Kit For 4"X6" Diamondback			1	27.24
0B80-2337-00	Chrome Bezel Kit For 7"X9" Diamondback			1	44.95
0C10-2228-10	Lens, 8080/8081 Series, Red			12	12.97
0C10-2228-30	Lens, 8080/8081 Series, Clear			12	12.97

\* Amp Draw is variable and application dependent  
 \*\* Refer to individual lamps

Part #	Description	AMP Draw		Std Cnt Qty	List Price - US Dollars
		12 V AMP	24 V AMP		
0C10-2228-40	Lens, 8080/8081 Series, Blue			12	12.97
0C10-2313-00	Inner Lens for 1020-9000			12	10.62
0C10-2327-00	Lens for 8035, Clear			12	7.98
0C11-1183-00	Lens, 1080 Series, Red			12	13.99
0C11-1223-00	Lens, 8086 Series, Red			12	12.97
0C11-1308-00	Lens, 2500 Series, Red			12	7.15
0C12-1181-00	Lens, Polycarb, 9186-8560-29 Series, Amber			12	6.87
0C12-1184-00	Lens, 1080 Series, Amber			12	13.99
0C12-1224-00	Lens, 8086 Series, Amber			12	8.30
0C13-1225-00	Lens, 8086 Series, Clear			12	12.95
0C14-1226-00	Lens, 8086 Series, Blue			12	8.30
0C20-2170-10	V37 Replacement Cover Lens, Red			6	21.06
0C20-2170-20	V37 Replacement Cover Lens, Amber			6	21.06
0C20-2170-30	V37 Replacement Cover Lens, Clear			6	21.06
0C20-2170-40	V37 Replacement Cover Lens, Blue			6	21.06
0C20-2177-10	V46 Replacement Cover Lens, Red			6	22.63
0C20-2177-20	V46 Replacement Cover Lens, Amber			6	22.63
0C20-2177-30	V46 Replacement Cover Lens, Clear			6	22.63
0C20-2177-40	V46 Replacement Cover Lens, Blue			6	22.63
0C20-2184-10	V79 Replacement Cover Lens, Red			6	39.42
0C20-2184-20	V79 Replacement Cover Lens, Amber			6	39.42
0C20-2184-30	V79 Replacement Cover Lens, Clear			6	39.42
0C20-2184-40	V79 Replacement Cover Lens, Blue			6	39.42
0C20-2191-10	V34 Replacement Cover Lens, Red			6	19.21
0C20-2191-20	V34 Replacement Cover Lens, Amber			6	19.21
0C20-2191-30	V34 Replacement Cover Lens, Clear			6	19.21
0C20-2191-40	V34 Replacement Cover Lens, Blue			6	19.21
0C20-2312-10	Cover Lens for 1020-9000, Red			12	10.89
0C20-2312-20	Cover Lens for 1020-9000, Amber			12	10.89
0C20-2401-10	Lens, for 8409 Dome, Frosted, Red			12	15.47
0C20-2401-30	Lens, for 8409 Dome, Frosted, Clear			12	15.47
0C20-2408-10	V26 Replacement Cover Lens, Red			6	16.66
0C20-2408-20	V26 Replacement Cover Lens, Amber			6	16.66
0C20-2408-30	V26 Replacement Cover Lens, Clear			6	16.66
0C20-2408-40	V26 Replacement Cover Lens, Blue			6	16.66
0C63-1180-00	Lens, Glass, 9186-8560 Series, Clear			12	16.41
0C80-2684-10	Lens/Gasket kit, 1017 Series 7" Red			12	13.83
0C80-2684-20	Lens/Gasket kit, 1017 Series 7" Amber			12	13.83
0C80-2684-30	Lens/Gasket kit, 1017 Series 7" Clear, Stop/Turn/Tail			12	13.83
0C80-2740-30	Lens/Gasket kit, 1017 Backup 7" Clear			12	13.83
0C90-0350-10	Lens Assy, 4X6 Halogen, Red			12	26.67
0C90-0350-20	Lens Assy, 4X6 Halogen, Amber			12	26.67
0C90-0350-30	Lens Assy, 4X6 Halogen, SF, Clear			12	26.67
0C90-0350-33	Sub-Assm, Lens/Refl, Scene Halogen, SF			12	24.41
0C90-0350-40	Lens Assy, 4X6 Halogen, Blue			12	29.27
0C90-0352-21	Lens Assy, 4X6 Left Arrow Turn, Amber			12	29.27
0C90-0352-22	Lens Assy, 4X6 Right Arrow Turn, Amber			12	29.27
0C90-1028-10	Sub-Assm, Lens/Refl, Red, Hal, SF, 3800			12	24.21
0C90-1028-20	Sub-Assm, Lens/Refl, Amber, Hal, SF, 3800			12	24.21
0C90-1028-30	Sub-Assm, Lens/Refl, Clear, Hal, SF, 3800			12	23.84
0C90-1028-33	Sub-Assm, Lens/Refl, Clear, Scene, SF, 3800			12	23.59
0C90-1028-40	Sub-Assm, Lens/Refl, Blue, Hal, SF, 3800			12	26.55

\* Amp Draw is variable and application dependent  
 \*\* Refer to individual lamps

Part #	Description	AMP Draw		Std Cnt Qty	List Price - US Dollars
		12 V AMP	24 V AMP		
0C90-1138-10	Assembly, Lens/Refl, SF-Red, 7800			12	29.66
0C90-1138-20	Assembly, Lens/Refl, SF-Amb, 7800			12	29.66
0C90-1138-33	Assembly, Lens/Refl, SF-Scene, 7800			12	29.66
0C90-1138-40	Assembly, Lens/Refl, SF-Blue, 7800			12	29.66
0C90-1139-10	Assembly, Lens/Refl, DF-Red, 7800			12	29.66
0C90-1139-20	Assembly, Lens/Refl, DF-Amber, 7800			12	29.66
0C90-1139-30	Assembly, Lens/Refl, DF-Clear, 7800			12	29.66
0D10-0334-00	Gasket, Between Light/Bezel, 4600 Series			12	4.64
0D10-1025-00	Gasket, Between Light/Bezel, 3800 Series			12	3.78
0D10-1135-00	Gasket, Between Light/Bezel, 7800 Series			12	4.64
0D10-1176-00	Gasket, Lens, 9186-8560 Series			12	4.15
0D10-1185-00	Gasket, Lens, 1080 Series			12	4.64
0D10-1208-00	Mounting Pad, 0J10-1200 Brush Guard			12	2.01
0D10-1530-00	Mounting Pad, 9186-1500 Series			12	2.00
0D10-1630-00	Mounting Pad, 5150/5180 Series			12	1.65
0D10-1977-00	Mounting Gasket for 1020-9000 & 1017-9000			12	3.13
0D10-2316-00	Lens Gasket for 1020-9000 & 1017-9000			12	4.07
0D10-2323-00	Lens Gasket for 8035 dome			12	4.16
0D10-2328-00	Mounting Pad for 8035 dome			12	4.68
0D10-2663-00	Mounting Pad for 1010-0300 or 1020-0300			12	10.89
0D30-0377-00	Mounting Pad, 4600 Series, Bezel			12	10.65
0D30-0385-00	Mounting Pad, 4600 Series, Panel			12	9.27
0D30-1026-00	Mounting Pad, 3800 Series, Bezel			12	10.65
0D30-1027-00	Mounting Pad, 3800 Series, Panel			12	9.27
0D30-1092-00	Mounting Pad, 9186-856X Series			12	5.41
0D30-1136-00	Mounting Pad, 7800 Series, Bezel			12	15.91
0D30-1137-00	Mounting Pad, 7800 Series, Panel			12	14.53
0D40-0512-00	Mounting Pad, 3884 Tri-Cluster			12	39.53
0D40-1143-00	Mounting Pad, 4684 Tri-Cluster			12	39.53
0D40-1144-00	Mounting Pad, 4694 Quad-Cluster			12	52.78
0D40-1203-00	Mounting Pad, 3894 Quad-Cluster			12	52.78
0D40-1339-01	Mounting Pad, 4681 Series			12	52.78
0E12-1146-00	Bulb, #2396, Incand, Sc, 40 CP			100	5.67
0E12-1263-00	Bulb, #1893, Incand, Mini, 2 CP			100	5.67
0E12-1266-00	Bulb, #53, Incand, Mini, 1 CP			100	5.67
0E13-1264-00	Bulb, #70, Incand, 1.5 CP			100	9.74
0E13-1469-00	Bulb, Miniature, #912, T-5, 12 CP			100	6.84
0E13-1878-00	Bulb, Miniature, #922, T-5, 15 CP			100	2.92
0E17-1265-00	Bulb, #1034, Incand, DC Index, 32 CP			100	5.67
0E22-0327-00	Bulb, 795X Halogen			100	9.94
0E22-1357-00	Bulb, #886, Hal, 100 CP			100	9.87
0E25-0769-00	Bulb, #G 6.35, Hal, 50 W			100	30.04
0E28-1060-00	Bulb, #H3, 55W 12V Hal. Pk225 B			100	8.18
0E30-2262-12	V-LED Kit, 1 watt, Red, 12 Pieces			1	70.65
0E30-2262-23	V-LED Kit, 1 watt, Amber, 12 Pieces			1	114.08
0E30-2262-37	V-LED Kit, 1 watt, Clear, 12 Pieces			1	116.70
0E93-1571-00	HID Bulb Adapter Assembly			1	214.68
0J10-0393-00	Bracket, for 9186-23882 Series, Black			10	21.41
0J10-0503-00	Bracket, Underbody Light 45Deg			48	18.62
0J10-1200-00	Brush Guard, Marker Lamp, SS For 9186-1500			50	5.58
0J10-2161-BK	Shield for 5150/5170/5180, Powder Coat Black			50	5.33

\* Amp Draw is variable and application dependent  
 \*\* Refer to individual lamps

Part #	Description	AMP Draw		Std Cnt Qty	List Price - US Dollars
		12 V AMP	24 V AMP		
0J10-2161-GY	Shield for 5150/5170/5180, Powder Coat Grey			50	5.33
0J50-1505-01	Mounting Bracket, Swivel, 6", for Vista			1	89.29
0J90-2114-00	Suction Cup Mount for Dash/Deck Lights			1	17.07
0J90-2637-01	Mounting Bracket Kit, Ford 1/2 Ton, 9188-1500			1	264.91
0J90-2637-02	Mounting Bracket Kit, Ford 3/4 Ton to 1 Ton, 9188-1500			1	264.91
0J90-2637-03	Mounting Bracket Kit, GM/Dodge 1/2 Ton to 1 Ton, 9188-1500			1	264.91
0K26-1260-00	Wire Remover Tool, 14-16 Gauge, V-MUX			1	6.52
0K90-0336-00	Socket, Single Contact 3800, 4600, 7800 Series			10	16.36
0K90-0337-00	Socket, Dual Contact 3800, 4600, 7800 Series			10	20.35
0K90-1291-10	2-Wire LED Plug Assy 3800, 4600, 7800 Series			100	8.26
0K90-1291-20	3-Wire LED Plug Assy 3800, 4600, 7800 Series			100	9.04
0K90-1549-10	Plug Assm, 3 Pos/2 Wire 1010-8100 Series			12	8.82
0K90-1549-20	Plug Assm, 3 Pos/3 Wire 1010-8100 Series			12	10.83
0K90-1601-00	Socket Wedge Base, w/Delphi for 5150			10	5.15
0K90-1704-00	Plug Assm, 3-Wire w/Weather Pack Conn for 1010-8111			10	20.25
0K90-1803-00	Plug Assm, 2 Wire, for 5150 and 5180 Series			10	7.62
0K90-1806-00	Kit, Scene Lamp 886 Upgrade			10	27.16
0K90-1969-10	2 Wire/Plug Assembly for 5800 Series or 1020-8100 non-strobing			1	9.48
0K90-1969-20	3 Wire/Plug Assembly for 5800 Series or 1020-8100 strobing			1	9.87
0K90-2869-00	3 Wire/Plug Assembly for 2710			1	17.08
0K90-3101-00	2 Wire/Plug Assembly for 8270-0100-30			1	16.33
0K90-3307-00	Plug Assembly 5 POS, 2351 Series			1	19.10
0K90-3308-00	Plug Assembly 5 POS, 2352 Series			1	19.10
0L40-2597-00	VDR Download Harness			1	54.00
0L90-0979-06	Kit, Cable, Strobe, 6' w/Connectors			6	11.90
0L90-0979-12	Kit, Cable, Strobe, 12' w/Connector			6	18.92
0L90-0979-20	Kit, Cable, Strobe, 20' w/Connector			6	27.25
0L90-0979-30	Kit, Cable, Strobe, 30' w/Connector			6	38.36
0L90-1244-00	Cable, One On One for Hercules, V-MUX			1	142.49
0L90-1876-00	Harness, Int. 7 Pin J560, Utm-2412			1	83.57
0M10-1328-10	Strobe Head Assy, 3800 Series, Red			12	79.79
0M10-1328-20	Strobe Head Assy, 3800 Series, Amber			12	79.79
0M10-1328-30	Strobe Head Assy, 3800 Series, Clear			12	79.79
0M10-1328-40	Strobe Head Assy, 3800 Series, Blue			12	89.14
0M10-1330-10	Strobe Head Assy, 4600 Series, Red			12	79.79
0M10-1330-20	Strobe Head Assy, 4600 Series, Amber			12	79.79
0M10-1330-30	Strobe Head Assy, 4600 Series, Clear			12	79.79
0M10-1330-40	Strobe Head Assy, 4600 Series, Blue			12	89.14
0M10-1379-12	Strobe Head Assy, 3800 Series, Red/Amber			12	95.70
0M10-1379-13	Strobe Head Assy, 3800 Series, Red/Clear			12	95.70
0M10-1379-14	Strobe Head Assy, 3800 Series, Red/Blue			12	95.70
0M10-1379-21	Strobe Head Assy, 3800 Series, Amber/Red			12	95.70
0M10-1379-23	Strobe Head Assy, 3800 Series, Amber/Clear			12	95.70
0M10-1379-31	Strobe Head Assy, 3800 Series, Clear/Red			12	95.70
0M10-1379-32	Strobe Head Assy, 3800 Series, Clear/Amber			12	95.70
0M10-1379-34	Strobe Head Assy, 3800 Series, Clear/Blue			12	95.70
0M10-1379-41	Strobe Head Assy, 3800 Series, Blue/Red			12	95.70
0M10-1379-43	Strobe Head Assy, 3800 Series, Blue/Clear			12	95.70
0M10-1428-10	Sub-Assy, 7800 Strobe, Red			12	79.79
0M10-1428-20	Sub-Assy, 7800 Strobe, Amber			12	79.79
0M10-1428-30	Strobe Head Assy, 7800 Series, Clear			12	79.79
0M10-1428-40	Sub-Assy, 7800 Strobe, Blue			12	89.14

\* Amp Draw is variable and application dependent  
 \*\* Refer to individual lamps

Part #	Description	AMP Draw		Std Cnt Qty	List Price - US Dollars
		12 V AMP	24 V AMP		
ON10-1063-00	Power Supply, Strobe, 40W, 2 Output			2	329.15
ON60-2508-00	Diamondback Wireless Programming Device			1	187.49
ON80-2485-00	PWM Converter Module			1	152.60
1000-1100-10	Turn w/Arrow 7" Round, Black Base, SB, #1156, Red	2.1		48	22.41
1000-1100-20	Turn w/Arrow, 7" Round, Black Base, SB, #1156, Amber	2.1		48	22.41
1000-1106-10	Turn w/Arrow, 7" Round, Black Base, SB, Ext. Grnd., #1156, Red	2.1		48	28.39
1000-1106-20	Turn w/Arrow, 7" Round, Black Base, SB, Ext. Grnd., #1156, Amber	2.1		48	28.39
1000-6300-10	Turn w/Arrow, 7" Round, Chr Flange, FB, #1156, Red	2.1		48	32.28
1000-6300-20	Turn w/Arrow, 7" Round, Chr Flange, FB, #1156, Amber	2.1		32	32.28
1000-7100-10	Turn w/Arrow, 7" Round, Black Base, FB, #1156, Red	2.1		32	24.40
1000-7100-20	Turn w/Arrow, 7" Round, Black Base, FB, #1156, Amber	2.1		32	24.40
1002-0000-10	Lens, Acrylic, 1010 Series, Arrow, 7", Red			24	17.04
1002-0000-20	Lens, Acrylic, 1010 Series, Arrow, 7", Amber			24	17.04
1003-0000-10	Lens, Acrylic, 1010 Series 7" Red			24	12.89
1003-0000-20	Lens, Acrylic, 1010 Series, 7" Amber			24	12.89
1003-0000-30	Lens, Acrylic, 1010 Series, 7" Clear			24	12.89
1003-0000-40	Lens, Acrylic, 1010 Series, 7" Blue			24	37.04
1003-0000-80	Lens, Polycarb, 8046 Series, Clear			24	19.71
1003-0050-10	Lens, Acrylic, 1010 Series Modified for Switch, Red			24	20.77
1003-0050-30	Lens, Acrylic, 1010 Series Modified for Switch, Clear			24	20.77
1003-1000-30	Lens, Acrylic, 1013 Backup, DOT, Clear			24	12.96
1004-0000-10	Lens, Acrylic, 7" 1020 Series, Red			24	11.62
1004-0000-20	Lens, Acrylic, 7" 1020 Series, Amber			24	11.62
1004-0000-30	Lens, Acrylic, 7" 1020 Series, Clear			24	11.62
1004-0000-40	Lens, Acrylic, 7" 1020 Series, Blue			24	37.62
1010-0300-10	Stop Or Turn, 7" Round, Chr Flange, SB, #1156, Red	2.1		32	31.02
1010-0300-20	Turn Signal, 7" Round, Chr Flange, SB, #1156, Amber	2.1		32	31.02
1010-0300-30	Dome, 7" Round, Chr Flange, SB, #1156, Clear	2.1		32	31.02
1010-0300-40	Dome, 7" Round, Chr Flange, SB, #1156, Blue	2.1		32	42.53
1010-0320-10	Stop & Tail, 7" Round, Chr Flg, SB, DC #1157, Red	2.1/0.59		32	33.04
1010-1100-10	Stop, 7" Round, Black Base, SB, #1156, Red	2.1		48	19.26
1010-1100-20	Turn, 7" Round, Black Base, SB, #1156, Amber	2.1		48	19.26
1010-1100-30	Dome, 7" Round, Black Base, SB, #1156, Clear	2.1		48	19.26
1010-1120-10	Stop & Tail, 7" Round, Black Base, SB, DC#1157, Red	2.1/0.59		48	20.78
1010-1120-20	Turn & Park, 7" Round, Black Base, SB, DC#1157, Amber	2.1/0.59		48	20.78
1010-1126-10	Stop & Tail, 7" Round, Black Base, SB, Ext. Grnd, #1157, Red	2.1/0.59		48	25.03
1010-6300-10	Stop, 7" Round, Chr Flange, FB, #1156, Red	2.1		32	33.04
1010-6300-20	Turn, 7" Round, Chr Flange, FB, #1156, Amber	2.1		32	33.04
1010-6300-30	Dome, 7" Round, Chr Flange, FB, #1156, Clear	2.1		32	33.04
1010-6310-10	Dome W/Switch, 7", Black Base, FB, #1142, Red	2.1		32	39.53
1010-6310-30	Dome W/Switch, 7", Black Base, FB, #1142, Clear	2.1		32	39.53
1010-6320-10	Stop & Tail, 7" Round, Chr Flange, FB, #1157, Red	2.1/0.59		32	36.91
1010-6320-20	Turn & Park, 7" Round, Chr Flange, FB, #1157, Amber	2.1/0.59		32	36.91
1010-6320-30	Dome, Hi-Low, 7" Round, Chr Flange, FB, #1157, Clear	2.1/0.59		32	36.91
1010-6390-30	Dome, 7" Round, Chr Flange, FB, #1295 37 CP, Clear	2.9		32	34.29
1010-7010-30	Dome, 7", Black Base, FB, #1142 21 CP, Clear	1.9		32	17.91
1010-7070-30	Dome, 7", Black Base, FB, #1141 21 CP, Clear	1.9		32	21.15
1010-7100-10	Stop, 7" Round, Black Base, FB, #1156, Red	2.1		32	20.53
1010-7100-20	Turn, 7" Round, Black Base, FB, #1156, Amber	2.1		32	20.53
1010-7100-30	Dome, 7" Round, Black Base, FB, #1156, Clear	2.1		32	20.53
1010-7120-10	Stop & Tail, 7" Round, Black Base, FB, #1157, Red	2.1/0.59		32	20.78

\* Amp Draw is variable and application dependent  
 \*\* Refer to individual lamps



Part #	Description	AMP Draw		Std Cnt Qty	List Price - US Dollars
		12 V AMP	24 V AMP		
1010-7120-20	Turn & Park, 7" Round, Black Base, FB, #1157, Amber	2.1/0.59		32	20.78
1010-7120-30	Dome, Hi-Low, 7" Round, Black Base, FB, #1157, Clear	2.1/0.59		32	20.78
1010-7190-30	Dome, 7" Round, Black Base, FB, #1295 37 CP, Clear	2.9		32	23.17
1010-8100-10	LED, 7" Stop & Tail, No Plug/Wires, Red	0.38/0.049		12	101.43
1010-8100-20	LED, 7" Turn & Park, No Plug/Wires, Amber	0.38/0.049		12	101.43
1010-8100-30	LED, 7" Dome/Auxiliary, No Plug, White	0.45		12	180.46
1010-8110-10	LED, 7" Stop/Tail w/Plug Assy, Red	0.38/0.049		12	105.44
1010-8110-1K	LED, 7" Stop/Tail Kit, 2 Lamps, Red, Best	**		1	189.77
1010-8110-20	LED, 7" Park/Turn w/Plug Assy, Amber	0.38/0.049		12	105.44
1010-8110-2K	LED, 7" Park/Turn Kit, 2 Lamps, Best	**		1	189.77
1010-8110-30	LED, 7" Dome/Auxiliary w/2-Wire Plug Assm, Clear	0.45		12	188.60
1010-8110-CK	LED, 7" Combo Kit, 2 Stop/Tail & 2 Park/Turn, Best	**		1	379.55
1010-8111-10	LED, 7" Stop/Tail w/Wthrpak Assy, Red	0.38/0.049		12	118.57
1010-8111-20	LED, 7" Park/Turn w/Wthrpak Assy, Amber	0.38/0.049		12	118.57
1010-9110-20	LED, 7" Turn w/2-Wire Plug Assm, Amber	0.38		12	94.32
1010-9110-21	LED, 7" Left Arrow Turn w/2-Wire Plug Assm, Amber	0.38		12	114.45
1010-9110-22	LED, 7" Right Arrow Turn w/2-Wire Plug Assm, Amber	0.38		12	114.45
1010-9110-30	Utility, 7" Black Base, FB #1076, Clear	2.1		32	24.40
1012-0000-00	Bulb Clip			100	1.18
1013-1100-30	Backup, 7" Round, Black Base, SB, #1141, Clear	1.9		48	20.53
1013-6300-30	Backup, 7" Round, Chr Flange, FB, #1141, Clear	1.9		32	31.02
1013-7100-30	Backup, 7" Round, Black Base, FB, #1141, Clear	1.9		32	20.53
1014-0000-00	Gasket, Lens, 1010, 1020 Series			12	3.32
1015-0000-00	Mounting Pad, 1010 Series			12	3.32
1016-0000-00	Mounting Pad, 1010 w/Chrome Flange			12	4.20
1017-9000-10	Stop & Tail, V-LED, 7" Round, Serviceable, Red			12	43.07
1017-9000-20	Turn & Park, V-LED, 7" Round, Serviceable, Amber			12	43.07
1017-9000-30	Backup, V-LED, 7" Round, Serviceable, Clear			12	49.70
1018-0000-00	Mounting Pad, 1020 Halogen Black Base			12	3.07
1020-1100-10	Warning, 80W, #4636, Red	2.3		36	39.53
1020-1100-20	Warning, 80W, #4636, Amber	2.3		36	39.53
1020-1100-40	Warning, 80W, #4636, Blue	2.3		36	55.41
1020-9000-10	LED Warning Lamp, 7" w/Wires, Red, Servicable	0.75		12	146.75
1020-9000-20	LED Warning Lamp, 7" w/Wires, Amber, Servicable	1.5		12	146.75
1020-9030-10	LED Warning Lamp, 7" w/Wires/AMP 250 con, Red, Servicable	0.75		12	156.30
1020-9030-20	LED Warning Lamp, 7" w/Wires/AMP 250 con, Amb, Servicable	1.5		12	156.30
1020-9090-10	LED Warning Lamp, 7" w/Wires/Singl AMP con, Red, Servicable	.75		12	156.30
1020-9090-20	LED Warning Lamp, 7" w/Wires/Singl AMP con, Amber, Servicable	1.5		12	156.30
1021-0000-00	Visor for 1020			120	11.90
1060-1100-10	Intersection Lamp, Rec Mt, Red	2.1		100	17.16
1060-1100-30	Backup, Rec Mt, #1156, Clear	2.1		100	17.16
1060-9100-30	Dome, Rec Mt, 1156 Bulb, Clear	2.1		100	17.16
1060-9200-30	Dome, Rec Mt, 1142 Bulb, Clear	1.9		100	25.03
1062-0000-10	Lens, Acrylic, 1060 Series, Red			12	6.35
1062-0000-30	Lens, Acrylic, 1060 Series, Clear			12	6.35
1063-0000-00	Mounting Pad, Black, 1060 Series			12	2.05
1063-0001-00	Mounting Pad Gray, 1060 Series			12	3.71
1064-0000-00	Gasket, Lens, 1060 Series			12	3.07
1080-1100-10	Warning, FB, Halogen, H3, Red	4		36	24.15
1080-1100-20	Warning, FB, Halogen, H3, Amber	4		36	24.15
1080-1106-10	Warning, FB, Halogen w/Grnd, H3, Red	4		36	27.03

\* Amp Draw is variable and application dependent  
 \*\* Refer to individual lamps

Part #	Description	AMP Draw		Std Cnt Qty	List Price - US Dollars
		12 V AMP	24 V AMP		
1080-1106-20	Warning, FB, Halogen w/Grnd, H3, Amber	4		36	27.03
1080S-1100-10	Warning, Stainless FB, Halogen, H3, Red			36	30.56
1080S-1100-20	Warning, Stainless FB, Halogen, H3, Amber			36	30.56
1080S-1106-10	Warning, Stainless FB, Halogen w/Grnd, H3, Red			36	33.47
1080S-1106-20	Warning, Stainless FB, Halogen w/Grnd, H3, Amber			36	33.47
2000-1100-10	Turn w/Arrow, 7X8 Horz, Black Base, SB, #1156, Red	2.1		32	25.77
2000-1100-20	Turn w/Arrow, 7X8 Horz, Black Base, SB, #1156, Amber	2.1		32	25.77
2000-6300-10	Turn w/Arrow, 7X8 Horz, Chr Base, FB, #1156, Red	2.1		32	39.53
2000-6300-20	Turn w/Arrow, 7X8 Horz, Chr Base, FB, #1156, Amber	2.1		32	39.53
2000-7100-10	Turn w/Arrow, 7X8 Horz, Black Base, FB, #1156, Red	2.1		32	25.77
2000-7100-20	Turn w/Arrow, 7X8 Horz, Black Base, FB, #1156, Amber	2.1		32	25.77
2002-0000-10	Lens, 7X8 Acrylic, 2000 Series, Arrow, Red			12	19.54
2002-0000-20	Lens, 7X8 Acrylic, 2000 Series, Arrow, Amber			12	19.54
2003-0000-00	Gasket, Lens, 2010 Series			12	3.45
2004-0000-00	Mounting Pad, 2000, 2010 Series			12	7.13
2004-0001-00	Mounting Pad, Gray, 2000, 2010 Series			12	7.13
2005-1100-10	Turn w/Arrow, 7X8 Vert, Black Base, SB, #1156, Red	2.1		32	25.77
2005-1100-20	Turn w/Arrow, 7X8 Vert, Black Base, SB #1156, Amber	2.1		32	25.77
2005-7100-10	Turn w/Arrow, Vert, FB, Black Base, #1156, Red	2.1		32	27.03
2005-7100-20	Turn w/Arrow, Vert, FB, Black Base, #1156, Amber	2.1		32	27.03
2008-0000-10	Lens, w/Arrow, 2005 Series, Vertical, Red			24	19.15
2008-0000-20	Lens, w/Arrow, 2005 Series, Vertical, Amber			24	19.15
2010-0300-30	Dome, 7X8, Chr Base, FB, #1156, Clear	2.1		32	35.67
2010-0370-30	Scene, 7X8, Chr Base, Rec Mt, #4436 35W, Clear	2.3		24	48.79
2010-0390-30	Scene, 7X8, Chr, Rec Mt, Halogen #H7635 50W, Clear	4.2		24	63.29
2010-1100-10	Stop, 7X8, Black Base, SB, #1156, Red	2.1		32	23.77
2010-1100-20	Turn, 7X8, Black Base, SB, #1156, Amber	2.1		32	23.77
2010-1100-30	Dome, 7X8, Black Base, SB, #1156, Clear	2.1		32	23.77
2010-1120-10	Stop & Tail, 7X8, Black Base, SB, #1157, Red	2.1/0.59		32	24.40
2010-1120-20	Turn & Park, 7X8, Black Base, SB, #1157, Amber	2.1/0.59		32	24.40
2010-1170-30	Scene, 7X8, Black Base, Rec Mt, Halogen H4436 35W, Clear	2.3		24	46.16
2010-1190-30	Scene, 7X8, Black Base, Rec Mt, Halogen #H7635 50W, Clear	4.2		24	52.78
2010-6300-10	Stop, 7X8, Chr Base, FB, #1156, Red	2.1		32	36.91
2010-6300-20	Turn, 7X8, Chr Base, FB, #1156, Amber	2.1		32	36.91
2010-6300-30	Dome, 7X8, Chr Base, FB, #1156, Clear	2.1		32	36.91
2010-6320-10	Stop & Turn, 7X8, Chr Base, FB, #1157, Red	2.1/0.59		32	38.29
2010-6320-20	Turn & Park, 7X8, Chr Base, FB, #1157, Amber	2.1/0.59		32	38.29
2010-7100-10	Stop, FB, Black Base, #1156, Red	2.1		32	24.40
2010-7100-20	Turn, FB, Black Base, #1156, Amber	2.1		32	24.40
2010-7100-30	Dome, 7X8, Black Base, FB, #1156, Clear	2.1		32	24.40
2010-7100-40	Dome, 7X8, Black Base, FB, #1156, Blue	2.1		32	40.90
2010-7120-10	Stop & Tail, 7X8, Black Base, FB #1157, Red	2.1/0.59		32	25.77
2010-7120-20	Turn & Park, 7X8, Black Base, FB #1157, Amber	2.1/0.59		32	25.77
2010-7120-30	Dome, 7X8, Black Base, FB #1157, Clear	2.1/0.59		32	25.77
2010-9110-30	Dome, 7X8, Black Base, FB #1076, Clear	2.1		32	28.39
2011-0000-10	Lens, 7X8 Acrylic, 2010 Series, Red			24	16.69
2011-0000-20	Lens, 7X8 Acrylic, 2010 Series, Amber			24	16.69
2011-0000-30	Lens, 7X8 Acrylic, 2010 Series, Clear			24	16.69
2011-0000-40	Lens, 7X8 Acrylic, 2010 Series, Blue			24	37.17
2020-0300-10	Warning, 80W #4636, Chr, Rec Mt, Red	5.75		24	57.03
2020-0300-20	Warning, 80W #4636, Chr, Rec Mt, Amber	5.75		24	57.03

\* Amp Draw is variable and application dependent  
 \*\* Refer to individual lamps

Part #	Description	AMP Draw		Std Cnt Qty	List Price - US Dollars
		12 V AMP	24 V AMP		
2020-0300-30	Warning, 80W #4636, Chr, Rec Mt, Clear	5.75		24	57.03
2020-0300-40	Warning, 80W #4636, Chr, Rec Mt, Blue	5.75		24	68.78
2020-1100-10	Warning, 80W #4636, Rec Mt, Red	5.75		24	45.16
2020-1100-20	Warning, 80W #4636, Rec Mt, Amber	5.75		24	45.16
2020-1100-40	Warning, 80W #4636, Rec Mt, Blue	5.75		24	54.65
2020-1170-10	Warning, 35W, #4436, Rec Mt, Red	2.75		24	45.16
2020-1170-20	Warning, 35W, #4436, Rec Mt, Amber	2.75		24	45.16
2020-1170-30	Warning, 35W, #4436, Rec Mt, Clear	2.75		24	45.16
2020-1170-40	Warning, 35W, #4436, Rec Mt, Blue	2.75		24	54.65
2020-1190-10	Warning, 50W Hal, H7635, Rec Mt, Red	3.9		24	61.54
2020-1190-20	Warning, 50W Hal, H7635, Rec Mt, Amber	3.9		24	61.54
2020-1190-30	Warning, 50W Hal, H7635, Rec Mt, Clear	3.9		24	61.54
2020-1190-40	Warning, 50W Hal, H7635, Rec Mt, Blue	3.9		24	72.41
2022-0000-10	Lens, 2020 Warning, Acrylic, Red			24	15.73
2022-0000-20	Lens, 2020 Warning, Acrylic, Amber			24	15.73
2022-0000-30	Lens, 2020 Warning, Acrylic, Clear			24	15.73
2022-0000-40	Lens, 2020 Warning, Acrylic, Blue			24	40.51
2023-0000-00	Mounting Pad, 2020 Series			24	7.13
2023-0001-00	Mounting Pad, Gray, 2020 Series			24	7.13
2025-7091-30	Pump Panel, Vert Mnt, #1141, no Grnd/Paint, Clear	1.9		96	14.42
2025-7100-30	Backup, Vert Mt, FB, #1156, Clear	2.1		96	15.60
2025-7130-30	Pump Panel, Vert Mnt, #1141, FB, Clear	1.9		96	16.06
2025-7190-30	Pump Panel, Vert Mnt, Flat Back, #93, Clear	1.1		96	16.06
2027-0000-30	Lens, Vert. B-U 2025, Clear			48	9.78
2028-0000-00	Gasket, Lens, 2025, 2035 Series			48	1.17
2029-0000-00	Mounting Pad, 2025, 2035 Series			48	2.57
2029-0001-00	Mounting Pad, Gray, 2025, 2035 Series			48	2.33
2030-1100-10	Stop, Socket Back, Black Base, #1156, Red	2.1		96	14.99
2030-1100-20	Turn, Socket Back, Black Base, #1156, Amber	2.1		96	14.99
2030-1120-10	Stop & Tail, Socket Back, Black Base, #1157, Red	2.1/0.59		96	16.28
2030-1120-20	Turn & Park, DC, Socket Back, Black Base, #1157, Amber	2.1/0.59		96	16.28
2030-7100-10	Stop, Flat Back, Black Base, #1156, Red	2.1		96	15.60
2030-7100-20	Turn, Flat Back, Black Base, #1156, Amber	2.1		96	15.60
2030-7100-30	Dome, #1156, Grnd Wire, FB, Clear	2.1		96	15.60
2030-7110-30	Dome, #1142, FB, Clear	1.9		96	17.46
2030-7120-10	Stop & Tail, Flat Back, Black Base, #1157, Red	2.1/0.59		96	17.59
2030-7120-20	Turn & Park, DC, FB, Black Base, #1157, Amber	2.1/0.59		96	17.59
2030-7120-30	Pump Panel, DC, #1157, FB, Clear	2.1/0.59		96	17.59
2030-7130-30	Pump Handle, Black Base, FB, #1141, Clear	1.9		96	16.64
2030-7190-30	Pump Panel, #93, FB, Black Base, Clear	1.1		96	16.88
2030-7530-30	Underbody, #1141, FB, SS, Clear	1.9		96	24.40
2030-9110-10	Dome, #1076, FB, Red	2.1		96	17.69
2030-9110-20	Dome, #1076, FB, Amber	2.1		96	17.69
2030-9110-30	Dome, #1076, FB, Clear	2.1		96	17.69
2032-0000-10	Lens, Acrylic, 2030, Red			48	9.74
2032-0000-20	Lens, Acrylic, 2030, Amber			48	9.74
2032-0000-30	Lens, Acrylic, 2030, Clear			48	9.74
2032-0000-40	Lens, Acrylic, 2030, Blue			12	31.26
2034-0000-00	Shield, 2030 Series Light Zinc			50	21.56
2034-0001-00	Shield, 2030 Series Light Blk			50	21.56
2034-0003-00	Shield, "Z" Bkt. 2030 Series, Black			50	20.77
2035-1100-30	Backup, Horz Optics, SB, #1156, Clear	2.1		96	14.91

\* Amp Draw is variable and application dependent  
 \*\* Refer to individual lamps

Part #	Description	AMP Draw		Std Cnt Qty	List Price - US Dollars
		12 V AMP	24 V AMP		
2035-7100-30	Backup, Horz Optics, FB, #1156, Clear	2.1		96	14.91
2035-7120-30	Dome, Horz Optics, FB, #1157 Clear	2.1/0.59		96	17.91
2035-7130-30	Pump Panel, Horz Mnt, Black Base, FB, #1141, Clear	1.9		96	15.45
2037-0000-30	Lens, Horiz. BU, 2035 Series, Clear			12	9.74
2351-0100-00	Rear Combination Lamp with License			24	50.26
2352-0100-00	Rear Combination Lamp without License			24	47.09
2500-1120-10	Stop, Turn & Tail, #1157, Red	2.1/0.59		48	8.02
2630-0000-30	Dome, Sealed Incand., 21 CP, Clear	1.44		72	12.16
2631-0000-30	LED Dome, Sealed, Clear	0.3		72	56.88
2710-0100-20	Amber LED Turn/Marker, Amber Lens	0.13	0.05	50	26.46
2710-1100-20	Amber LED Turn/Marker, Clear Lens	0.13	0.05	50	28.58
3010-1500-30	Scene, 15 Deg Tilt, Hal, #GH22, Clear	4.2		24	104.71
3010-2600-30	Scene, 26 Deg Tilt Hal, GH22, Clear	4.2		24	104.71
3011-0000-30	Lens, Polycarb. 15 Deg., 3010 Series, Clear			12	44.19
3012-0000-30	Lens, Polycarb 26 Deg, 3010 Series, Clear			12	44.19
3020-0390-10	Warning, Dual Bulb, Hal GH22, Red	4.2		24	98.81
3020-0390-20	Warning, Dual Bulb, Hal GH22, Amber	4.2		24	98.81
3020-0390-30	Warning, Dual Bulb, Hal GH22, Clear	4.2		24	98.81
3020-0390-40	Warning, Dual Bulb, Hal GH22, Blue	4.2		24	108.67
3022-0000-10	Lens, Polycarb, 3020 Series, Red			12	44.50
3022-0000-20	Lens, Polycarb, 3020 Series, Amber			12	44.50
3022-0000-30	Lens, Polycarb, 3020 Series, Clear			12	44.50
3022-0000-40	Lens, Polycarb, 3020 Series, Blue			12	54.67
3023-0001-00	Mounting Pad, 3010/3020			12	5.72
3024-0001-00	Gasket, 3010/3020 Lens			12	5.72
3200-0000-13	Supplemental Warning Light Kit			1	669.65
3201-0000-13	Supplemental Warning Light Head, Red/White			1	134.92
3811-0000-10	Warning, 3X7 Halogen #795X, Panel/Red	4.2		6	54.33
3811-0000-12	Warning, 3X7 Halogen #795X, Panel Split Red/Amber	4.2		6	63.55
3811-0000-13	Warning, 3X7 Halogen #795X, Panel Split Red/Clear	4.2		6	63.55
3811-0000-14	Warning, 3X7 Halogen #795X, Panel Split Red/Blue	4.2		6	63.55
3811-0000-20	Warning, 3X7 Halogen #795X, Panel/Amber	4.2		6	54.33
3811-0000-21	Warning, 3X7 Halogen #795X, Panel Split Amber/Red	4.2		6	63.55
3811-0000-23	Warning, 3X7 Halogen #795X, Panel Split Amber/Clear	4.2		6	63.55
3811-0000-30	Warning, 3X7 Halogen #795X, Panel/Clear	4.2		6	54.33
3811-0000-31	Warning, 3X7 Halogen #795X, Panel Split Clear/Red	4.2		6	63.55
3811-0000-32	Warning, 3X7 Halogen #795X, Panel Split Clear/Amber	4.2		6	63.55
3811-0000-33	Scene, 3X7, Panel, #886, Clear	3.9		6	57.21
3811-0000-34	Warning, 3X7 Halogen #795X, Panel Split Clear/Blue	4.2		6	63.55
3811-0000-40	Warning, 3X7 Halogen #795X, Panel/Blue	4.2		6	54.33
3811-0000-41	Warning, 3X7 Halogen #795X, Panel Split Blue/Red	4.2		6	63.55
3811-0000-43	Warning, 3X7 Halogen #795X, Panel Split Blue/Clear	4.2		6	63.55
3812-0000-10	Warning, 3X7 Halogen #795X, Bezel/Red	4.2		6	71.18
3812-0000-12	Warning, 3X7 Halogen #795X, Bezel Split Red/Amber	4.2		6	82.72
3812-0000-13	Warning, 3X7 Halogen #795X, Bezel Split - LH Red/Clear	4.2		6	82.72
3812-0000-14	Warning, 3X7 Halogen #795X Assy, Split- RH Red/Blue	4.2		6	82.72
3812-0000-20	Warning, 3X7 Halogen #795X, Bezel/Amber	4.2		6	71.18
3812-0000-21	Warning, 3X7 Halogen #795X, Bezel Split Amber/Red	4.2		6	82.72
3812-0000-23	Warning, 3X7 Halogen #795X, Bezel Split Amber/Clear	4.2		6	82.72
3812-0000-30	Warning, 3X7 Halogen #795X, Bezel/Clear	4.2		6	71.18
3812-0000-31	Warning, 3X7 Halogen #795X, Bezel Split Clear/Red	4.2		6	82.72
3812-0000-32	Warning, 3X7 Halogen #795X, Bezel Split Clear/Amber	4.2		6	82.72

\* Amp Draw is variable and application dependent  
 \*\* Refer to individual lamps

Part #	Description	AMP Draw		Std Cnt Qty	List Price - US Dollars
		12 V AMP	24 V AMP		
3812-0000-33	Scene, 3X7, Bezel, #886, Clear	3.9		6	76.77
3812-0000-34	Warning, 3X7 Halogen #795X, Bezel Split Clear/Blue	4.2		6	82.72
3812-0000-40	Warning, 3X7 Halogen #795X, Bezel/Blue	4.2		6	71.18
3812-0000-41	Warning, 3X7 Halogen #795X, Bezel Split Blue/Red	4.2		6	82.72
3812-0000-43	Warning, 3X7 Halogen #795X, Bezel Split Blue/Clear	4.2		6	82.72
3821-0000-10	Strobe, 3X7 Warning, Panel, Red	*	*	6	101.01
3821-0000-12	Strobe, 3X7 Warning, Panel, Split Red/Amber	*	*	6	109.09
3821-0000-13	Strobe, 3X7 Warning, Panel, Split Red/Clear	*	*	6	109.09
3821-0000-14	Strobe, 3X7 Warning, Panel, Split Red/Blue	*	*	6	109.09
3821-0000-20	Strobe, 3X7 Warning, Panel, Amber	*	*	6	101.01
3821-0000-21	Strobe, 3X7 Warning, Panel, Split Amber/Red	*	*	6	109.09
3821-0000-23	Strobe, 3X7 Warning, Panel, Split - LH Amber/Clear	*	*	6	109.09
3821-0000-30	Strobe, 3X7 Warning, Panel, Clear	*	*	6	101.01
3821-0000-31	Strobe, 3X7 Warning, Panel, Split Clear/Red	*	*	6	109.09
3821-0000-32	Strobe, 3X7 Warning, Panel, Split Clear/Amber	*	*	6	109.09
3821-0000-34	Strobe, 3X7 Warning, Panel, Split Clear/Blue	*	*	6	109.09
3821-0000-40	Strobe, 3X7 Warning, Panel, Blue	*	*	6	101.01
3821-0000-41	Strobe, 3X7 Warning, Panel, Split - LH Blue/Red	*	*	6	109.09
3821-0000-43	Strobe, 3X7 Warning, Panel Split Blue/Clear	*	*	6	109.09
3822-0000-10	Strobe, 3X7 Warning, Bezel, Red	*	*	6	118.29
3822-0000-12	Strobe, 3X7 Warning, Bezel, Split Red/Amber	*	*	6	126.25
3822-0000-13	Strobe, 3X7 Warning, Bezel, Split Red/Clear	*	*	6	126.25
3822-0000-14	Strobe, 3X7 Warning, Bezel, Split Red/Blue	*	*	6	126.25
3822-0000-20	Strobe, 3X7 Warning, Bezel, Amber	*	*	6	118.29
3822-0000-21	Strobe, 3X7 Warning, Bezel, Split Amber/Red	*	*	6	126.25
3822-0000-23	Strobe, 3X7 Warning, Bezel, Split Amber/Clear	*	*	6	126.25
3822-0000-30	Strobe, 3X7 Warning, Bezel, Clear	*	*	6	118.29
3822-0000-31	Strobe, 3X7 Warning, Bezel, Split Clear/Red	*	*	6	126.25
3822-0000-32	Strobe, 3X7 Warning, Bezel, Split Clear/Amber	*	*	6	126.25
3822-0000-34	Strobe, 3X7 Warning, Bezel, Split Clear/Blue	*	*	6	126.25
3822-0000-40	Strobe, 3X7 Warning, Bezel, Blue	*	*	6	126.25
3822-0000-41	Strobe, 3X7 Warning, Bezel, Split Blue/Red	*	*	6	126.25
3822-0000-43	Strobe, 3X7 Warning, Bezel, Split Blue/Clear	*	*	6	126.25
3841-0000-10	Stop, 3X7, Panel, #1156, Red	2.1		6	57.37
3841-0000-20	Turn, 3X7, Panel, #3497, Amber	2.1		6	57.37
3841-0000-21	Turn, 3X7 Turn w/Arrow LH, Panel, #3497, Amber	2.1		6	62.18
3841-0000-22	Turn, 3X7 Turn w/Arrow RH, Panel, #3497, Amber	2.1		6	62.18
3841-0000-30	Backup, 3X7 Panel, #3497, Clear	2.1		6	57.37
3842-0000-10	Stop, 3X7, Bezel, #1156, Red	2.1		6	70.21
3842-0000-20	Turn, 3X7, Bezel, #3497, Amber	2.1		6	70.21
3842-0000-21	Turn, 3X7 Turn w/Arrow LH, Bezel, #3497, Amber	2.1		6	77.36
3842-0000-22	Turn, 3X7 Turn w/Arrow RH, Bezel, #3497, Amber	2.1		6	77.36
3842-0000-30	Backup, 3X7 Bezel, #3497, Clear	2.1		6	70.21
3851-0000-10	Stop & Tail, 3X7, Panel, #2357, Red	2.2/0.59		6	57.37
3851-0000-20	Turn & Park, 3X7, Panel, #2357, Amber	2.2/0.59		6	57.37
3852-0000-10	Stop & Tail, 3X7, Bezel, #2357, Red	2.2/0.59		6	70.21
3852-0000-20	Stop & Tail, 3X7, Bezel, #2357, Amber	2.2/0.59		6	70.21
3862-0000-33	HID Scene, 3X7, Bezel, Clear	2.6		6	599.65
3862-0000-3K	HID Scene Kit, 3X7, 2 Lamps, Clear	**		1	1,078.58
3871-1000-10	LED, 3X7 Warning, Panel, Red	0.8	0.42	6	240.67
3871-1000-20	LED, 3X7 Warning, Panel, Amber	0.8	0.42	6	240.67
3871-1000-30	LED, 3X7 Warning, Panel, Clear	0.8	0.44	6	346.00
3871-1000-40	LED, 3X7 Warning, Panel, Blue	0.8	0.44	6	500.00

\* Amp Draw is variable and application dependent  
 \*\* Refer to individual lamps



Part #	Description	AMP Draw		Std Cnt Qty	List Price - US Dollars
		12 V AMP	24 V AMP		
3871-2000-10	LED, 3X7 Stop & Tail, Panel, Red	.65/.11	.31/.04	6	180.50
3871-6000-21	LED, 3X7 Seq Turn w/Arrow LH, Panel, Amber	0.89	0.4	6	233.40
3871-6000-22	LED, 3X7 Seq Turn w/Arrow RH, Panel, Amber	0.89	0.4	6	233.40
3871-8000-30	LED, 3X7 Auxilliary Backup, Panel, Clear	0.62	0.44	6	346.47
3872-1000-10	LED, 3X7 Warning, Bezel, Red	0.8	0.42	6	259.34
3872-1000-20	LED, 3X7 Warning, Bezel, Amber	0.8	0.42	6	259.34
3872-1000-30	LED, 3X7, Warning, Bezel, Clear	0.8	0.44	6	519.00
3872-1000-40	LED, 3X7 Warning, Bezel, Blue	0.8	0.44	6	519.00
3872-2000-10	LED, 3X7 Stop & Tail, Bezel, Red	0.65/0.11	0.31/0.04	6	200.22
3872-6000-21	LED, 3X7 Seq Turn w/Arrow LH, Bezel, Amber	0.89	0.4	6	253.12
3872-6000-22	LED, 3X7 Seq Turn w/Arrow RH, Bezel, Amber	0.89	0.4	6	253.12
3872-8000-30	LED, 3X7 Auxilliary Backup, Bezel, Clear	0.62	0.44	6	366.19
3884-0000-00	Tri: 3X7 Lamps, S, T, Amber Turn, Backup	**		4	313.28
3884-0000-01	Tri: 3X7 Lamps, S, T, Amber Turn w/Ar, Back - LH	**		4	320.54
3884-0000-02	Tri: 3X7 Lamps, S, T, Amber Turn w/Ar, Back - RH	**		4	320.54
3884-0000-18	Tri: 3X7 Lamps, LED Stop & Tail, Amber Seq Turn & Backup-LH	**		4	904.55
3884-0000-19	Tri: 3X7 Lamps, LED Stop & Tail, Amber Seq Turn & Backup-RH	**		4	904.55
3884-0000-28	Tri: 3X7 Lamps, LED Stop & Tail, Amber Seq Turn, Incand Backup-LH	**		4	631.74
3884-0000-29	Tri: 3X7 Lamps, LED Stop & Tail, Amber Seq Turn, Incand Backup-RH	**		4	631.74
3884-0100-00	Tri: 3X7 Lamps, S, T, Amber Turn w/Packard	**		4	399.37
3884-0100-01	Tri: 3X7 Lamps, S, T, Amber Tw/Ar w/Packard - LH	**		4	326.76
3884-0100-02	Tri: 3X7 Lamps, S, T, Amber Tw/Ar w/Packard - RH	**		4	326.76
3884-0100-18	Tri: 3X7 Lamps, LED Stop & Tail, Amber Seq Turn & Backup w/Packard-LH	**	**	4	904.55
3884-0100-19	Tri: 3X7 Lamps, LED Stop & Tail, Amber Seq Turn & Backup w/Packard-RH	**	**	4	904.55
3884-0100-28	Tri: 3X7 Lamps, LED Stop & Tail, Amber Seq Turn, Incand Backup w/Packard-LH	**		4	614.10
3884-0100-29	Tri: 3X7 Lamps, LED Stop & Tail, Amber Seq Turn, Incand Backup w/Packard-RH	**		4	614.10
3884-0200-00	Tri: 3X7 Lamps, S, T, Amber Turn w/Deutsch	**		4	326.76
3884-0200-01	Tri: 3X7 Lamps, Stop & Tail, Amber w/Arrow w/Deutsch - LH	**		4	334.02
3884-0200-02	Tri: 3X7 Lamps, Stop & Tail, Amber w/Arrow w/Deutsch - RH	**		4	334.02
3884-0200-18	Tri: 3X7 Lamps, LED Stop & Tail, Amb Seq Turn & Backup w/Deutsch-LH	**	**	4	904.55
3884-0200-19	Tri: 3X7 Lamps, LED Stop & Tail, Amber Seq Turn & Backup w/Deutsch-RH	**	**	4	904.55
3884-0200-28	Tri: 3X7 Lamps, LED Stop & Tail, Amber Seq Turn, Incand Backup w/Deutsch-LH	**		4	614.10
3884-0200-29	Tri: 3X7 Lamps, LED Stop & Tail, Amber Seq Turn, Incand Backup w/Deutsch-RH	**		4	614.10
3884-1000-01	Tri: 3X7 Lamps, Amber Turn w/Arrow, Stop & Tail, Backup - LH	**		4	320.54
3884-1000-02	Tri: 3X7 Lamps, Amber Turn w/Arrow, Stop & Tail, Backup - RH	**		4	320.54
3884-1100-01	Tri: 3X7 Lamps, Stop & Tail, Amber w/Arrow w/Packard - LH	**		4	326.76
3884-1100-02	Tri: 3X7 Lamps, Stop & Tail, Amber w/Arrow w/Packard - RH	**		4	326.76
3884-1200-01	Tri: 3X7 Lamps, Amber w/Arrow, Stop & Tail, w/Deutsch - LH	**		4	334.02
3884-1200-02	Tri: 3X7 Lamps, Amber w/Arrow, Stop & Tail, w/Deutsch - RH	**		4	334.02
3884-2000-00	Tri: 3X7 Lamps, Stop & Tail, Red Turn, Backup	**		4	306.01
3884-8011-00	Tri: 3X7 Lamps, Stop, Tail & Turn, Backup & Red Halogen	**		4	306.01
3884-8012-00	Tri: 3X7 Lamps, Stop & Tail, T, Backup & Amber Halogen	**		4	306.01
3884-8090-00	Tri: Stop/Tail: Turn/Tail: Bkup	**		4	313.28
3884-9000-00	Tri: [Open]   Stop & Tail   Rev	**		4	299.80
3884-LA2K	LED Seq Turn Kit, 3X7, 2 Lamps, Amber	**	**	1	442.94
3884-LC2K	LED Backup Kit, 3X7, 2 Lamps, Clear	**	**	1	657.67
3884-LR2K	LED Stop/Tail Kit, 3X7, 2 Lamps, Red	**	**	1	342.32
3894-0000-01	Quad: 3X7 Lamps, Stop, Tail & Turn, Backup, Open - LH	**		4	393.15
3894-0000-02	Quad: 3X7 Lamps, Stop, Tail & Turn, Backup, Open - RH	**		4	393.15
3894-0011-01	Quad: 3X7 Lamps, Red Hal Warning, Stop & Tail, Amber w/Arrow, Backup - LH	**		4	433.61
3894-0011-02	Quad: 3X7 Lamps, Red Hal Warning, Stop & Tail, Amber w/Arrow, Backup - RH	**		4	433.61
3894-0012-01	Quad: 3X7 Lamps, Amb Hal Warning, Stop & Tail, Amber w/Arrow, Backup - LH	**		4	433.61

\* Amp Draw is variable and application dependent  
 \*\* Refer to individual lamps

Part #	Description	AMP Draw		Std Cnt Qty	List Price - US Dollars
		12 V AMP	24 V AMP		
3894-0012-02	Quad: 3X7 Lamps, Amb Hal Warning, Stop & Tail, Amber w/Arrow, Backup - RH	**		4	433.61
3894-0071-28	Quad: 3X7 Lamps, LED Warning-Red, Stop & Tail, Amb Seq Turn & Incand Backup-LH	**		4	931.53
3894-0071-29	Quad: 3X7 Lamps, LED Warning-Red, Stop & Tail, Amb Seq Turn & Incand Backup-RH	**		4	931.53
3894-0161-18	Quad: 3X7 Lamps, LED Stop & Tail, Amb Seq Turn, Backup, Warning-Red-LH	**	**	4	1,290.44
3894-0161-19	Quad: 3X7 Lamps, LED Stop & Tail, Amb Seq Turn, Backup, Warning-Red-RH	**	**	4	1,290.44
3894-0200-01	Quad: 3X7 Lamps, Open, Stop & Tail, Amber w/Arrow, Backup w/Deutsch-LH	**		4	439.83
3894-0200-02	Quad: 3X7 Lamps, Open, Stop & Tail, Amber w/Arrow, Backup w/Deutsch-RH	**		4	439.83
3894-0250-01	Quad: 3X7 Lamps, Stop & Tail, Amber w/Arrow, Backup, Open w/Deutsch-LH	**		4	419.09
3894-0250-02	Quad: 3X7 Lamps, Stop & Tail, Amber w/Arrow, Backup, Open w/Deutsch-RH	**		4	419.09
3894-0271-28	Quad: 3X7 Lamps, LED Warning-Red, Stop & Tail, Amb Seq Turn & Incand Backup w/Deutsch-LH	**		4	931.53
3894-0271-29	Quad: 3X7 Lamps, LED Warning-Red, Stop & Tail, Amb Seq Turn & Incand Backup w/Deutsch-RH	**		4	951.53
3894-0531-28	Quad: 3X7 Lamps, Stop & Tail, Amb Seq Turn & Incand Backup Hal Warn-Red w/Deutsch-LH	**		4	699.16
3894-0531-29	Quad: 3X7 Lamps, Stop & Tail, Amb Seq Turn & Incand Backup Hal Warn-Red w/Deutsch-RH	**		4	699.16
3894-1100-01	Quad: 3X7 Lamps, Stop & Tail, Amber w/Arrow, Backup, Red Hal Warning-LH	**		4	433.61
3894-1100-02	Quad: 3X7 Lamps, Stop & Tail, Amber w/Arrow, Backup, Red Hal Warning-RH	**		4	433.61
3894-1200-01	Quad: 3X7 Lamps, (Open), Lt. Arr, Stop & Tail, Backup	**		4	419.09
3894-1200-02	Quad: 3X7 Lamps, (Open), Rt. Arr, Stop & Tail, Backup	**		4	419.09
3901-1604-00	Light Bar, 2 Lamp, Roadside, Hemitt	**	**	1	1,359.00
3901-1605-00	Light Bar, 2 Lamp, Curbside, Hemitt	**	**	1	1,359.00
3901-5903-00	Light Bar, 8 Lamp, Hemitt	**	**	1	3,389.00
3902-7408-00	Light Bar: All LED, 10-Lamp, All Red	**	**	1	3,813.00
3902-7411-00	Light Bar: LED/Halogen, 10-Lamp, Ems Front, R/R/R/R/CH/CH/R/R/R/R	**	**	1	3,294.00
3902-8125-00	Light Bar 11-Lamp Straight 8Rl+3Cs	**	**	1	4,723.00
3902-8813-00	Light Bar: All LED, 12-Lamp, EMS Rear, R/R/R/R/SC/A/A/SC/R/R/R/R	**	**	1	4,180.00
3902-8816-00	Light Bar: All LED, 12-Lamp, EMS Front, R/R/R/R/R/CH/CH/R/R/R/R/R/R	**	**	1	4,180.00
3902-8831-00	Light Bar 12-Lamp, St 6Bl+2St+2Hs+2At	**	**	1	5,881.00
3910-7202-00	Light Bar, 14 Red LED Wrap Around	**	**	1	6,369.00
3913-7218-00	Light Bar: All LED, 12-Lamp Wrap-Around Design, All Red	**	**	1	6,368.00
3913-8501-00	Light Bar: All LED, 16-Lamp Wrap-Around Design, All Red	**	**	1	7,096.00
4611-0000-10	Warning, 4X6 Halogen #795X, Panel, Red	4.2		6	54.33
4611-0000-20	Warning, 4X6 Halogen #795X, Panel, Amber	4.2		6	54.33
4611-0000-30	Warning, 4X6 Halogen #795X, Panel, Clear	4.2		6	54.33
4611-0000-33	Scene, 4X6 Halogen, Panel, #886, Clear	3.9		6	58.57
4611-0000-40	Warning, 4X6 Halogen #795X, Panel, Blue	4.2		6	54.33
4612-0000-10	Warning, 4X6, Halogen #795X, Bezel, Red	4.2		6	73.95
4612-0000-20	Warning, 4X6, Halogen #795X, Bezel, Amber	4.2		6	73.95
4612-0000-30	Warning, 4X6, Halogen #795X, Bezel, Clear	4.2		6	73.95
4612-0000-33	Scene, 4X6 Halogen, Bezel, #886, Clear	3.9		6	78.19
4612-0000-40	Warning, 4X6, Halogen #795X, Bezel, Blue	4.2		6	73.95
4613-0000-10	Warning, 4X6, Halogen #795X, Headlamp Mt, Red	4.2		6	62.51
4613-0000-20	Warning, 4X6, Halogen #795X, Headlamp Mt, Amber	4.2		6	62.51
4613-0000-30	Warning, 4X6, Halogen #795X, Headlamp Mt, Clear	4.2		6	62.51
4613-0000-40	Warning, 4X6, Halogen #795X, Headlamp Mt, Blue	4.2		6	62.51
4621-0000-10	Strobe, Warning 4X6, Panel, Red	*	*	6	113.00
4621-0000-20	Strobe, Warning 4X6, Panel, Amber	*	*	6	113.00
4621-0000-30	Strobe, Warning 4X6, Panel, Clear	*	*	6	113.00
4621-0000-40	Strobe, Warning 4X6, Panel, Blue	*	*	6	113.00
4622-0000-10	Strobe, Warning 4X6, Bezel, Red	*	*	6	131.68
4622-0000-20	Strobe, Warning 4X6, Bezel, Amber	*	*	6	131.68
4622-0000-30	Strobe, Warning 4X6, Bezel, Clear	*	*	6	131.68
4622-0000-40	Strobe, Warning 4X6, Bezel, Blue	*	*	6	131.68
4623-0000-10	Strobe, Warning 4X6, Headlamp, Red	*	*	6	122.36
4623-0000-20	Strobe, Warning 4X6, Headlamp, Amber	*	*	6	122.36

\* Amp Draw is variable and application dependent  
 \*\* Refer to individual lamps

Part #	Description	AMP Draw		Std Cnt Qty	List Price - US Dollars
		12 V AMP	24 V AMP		
4623-0000-30	Strobe, Warning 4X6, Headlamp, Clear	*	*	6	122.36
4623-0000-40	Strobe, Warning 4X6, Headlamp, Blue	*	*	6	122.36
4641-0000-10	Stop, 4X6, Panel, #1156, Red	2.1		6	52.37
4641-0000-20	Turn, 4X6, Panel, #1156, Amber	2.1		6	52.37
4641-0000-21	Turn, 4X6, w/Arrow LH, Panel, #1156, Amber	2.1		6	57.73
4641-0000-22	Turn, 4X6, w/Arrow RH, Panel, #1156, Amber	2.1		6	57.73
4641-0000-30	Backup, 4600 Series, Panel, #1156, Clear	2.1		6	52.37
4642-0000-10	Stop, 4X6, Bezel, #1156, Red	2.1		6	70.21
4642-0000-20	Turn, 4X6, Bezel, #1156, Amber	2.1		6	70.21
4642-0000-21	Turn, 4X6, w/Arrow LH, Bezel, #1156, Amber	2.1		6	75.23
4642-0000-22	Turn, 4X6, w/Arrow RH, Bezel, #1156, Amber	2.1		6	75.23
4642-0000-30	Backup, 4600 Series, Bezel, #1156, Clear	2.1		6	70.21
4643-0000-20	Turn, 4X6, Headlamp, #1156, Amber	2.1		6	59.75
4643-0000-21	Turn, 4X6, w/Arrow, LH, Headlamp, #1156, Amber	2.1		6	65.47
4643-0000-22	Turn, 4X6, w/Arrow, RH, Headlamp, #1156, Amber	2.1		6	65.47
4651-0000-10	Stop & Tail, 4X6, Panel, #1157, Red	2.1/0.59		6	54.64
4651-0000-20	Turn & Park, 4X6, Panel, #1157, Amber	2.1/0.59		6	54.64
4652-0000-10	Stop & Tail, 4X6, Bezel, #1157, Red	2.1/0.59		6	74.27
4652-0000-20	Turn & Park, 4X6, Bezel, #1157, Amber	2.1/0.59		6	74.27
4653-0000-20	Turn & Park, 4X6, Headlamp, #1157, Amber	2.1/0.59		6	59.86
4662-0000-33	HID Scene, 4X6, Bezel, Clear	2.6		6	611.64
4662-0000-3K	HID Scene Kit, 4X6, 2 Lamps, Clear	**		1	1,103.13
4670-1000-1K	NFPA Lower Zone A LED Lamp Kit	**	**	1	601.00
4671-1000-10	LED, 4X6 Warning, Panel, Red	0.9	0.35	6	320.00
4671-1000-20	LED, 4X6 Warning, Panel, Amber	0.9	0.35	6	320.00
4671-1000-30	LED, 4X6 Warning, Panel, Clear	0.9	0.36	6	399.00
4671-1000-40	LED, 4X6 Warning, Panel, Blue	0.9	0.36	6	545.00
4671-2000-10	LED, 4X6 Stop & Tail, Panel, Red	0.69/0.12	0.31/0.04	6	200.00
4671-6000-21	LED, 4X6 Seq Turn w/Arrow, Panel, Left, Amber	0.81	0.68	6	223.00
4671-6000-22	LED, 4X6 Seq Turn w/Arrow, Panel, Right, Amber	0.81	0.68	6	223.00
4671-8000-30	LED, 4X6 Auxilliary Backup, Panel, Clear	0.62	0.36	6	399.00
4672-1000-10	LED, 4X6 Warning, Bezel, Red	0.9	0.35	6	340.00
4672-1000-20	LED, 4X6 Warning, Bezel, Amber	0.9	0.35	6	340.00
4672-1000-30	LED, 4X6 Warning, Bezel, Clear	0.9	0.36	6	433.00
4672-1000-40	LED, 4X6 Warning, Bezel, Blue	0.9	0.36	6	573.00
4672-2000-10	LED, 4X6 Stop & Tail, Bezel, Red	0.9	.31/.04	6	223.00
4672-6000-21	LED, 4X6 Seq Turn w/Arrow, Bezel, Left, Amber	0.9	0.68	6	253.00
4672-6000-22	LED, 4X6 Seq Turn w/Arrow, Bezel, Right, Amber	0.9	0.68	6	253.00
4672-8000-30	LED, 4X6 Auxilliary Backup, Bezel, Clear	0.9	0.36	6	433.00
4673-1000-10	LED, 4X6 Warning, Headlamp Mt, Red	0.9	0.35	6	316.00
4673-1000-20	LED, 4X6 Warning, Headlamp Mt, Amber	0.9	0.35	6	316.00
4673-1000-30	LED, 4X6 Warning, Headlamp Mt, Clear	0.9	0.36	6	554.00
4673-1000-40	LED, 4X6 Warning, Headlamp Mt, Blue	0.9	0.36	6	554.00
4673-6000-21	LED, 4X6 Seq Turn w/Arrow, Headlamp Mt, Left, Amber	0.81	0.68	6	224.00
4673-6000-22	LED, 4X6 Seq Turn w/Arrow, Headlamp Mt, Right, Amber	0.81	0.68	6	224.00
4681-3200-01	Tri: Horz, S & T, Amber w/Arrow, Backup - LH	**		4	326.96
4681-3200-18	Tri: Horz, LED S & T, Amber w/Arrow, Backup - LH	**	**	4	951.21
4681-3200-28	Tri: Horz, LED S & T, Amber w/Arrow, Incand Backup - LH	**		4	609.46
4682-3200-02	Tri: Horz, S & T, Amber w/Arrow, Backup - RH	**		4	326.96
4682-3200-19	Tri: Horz, LED S & T, Amber w/Arrow, Backup - LH	**	**	4	951.21
4682-3200-29	Tri: Horz, LED S & T, Amber w/Arrow, Incand Backup - RH	**		4	609.46
4684-0000-01	Tri: 4X6 Lamps: Stop & Tail, Amber w/Arrow, Backup - LH	**		4	310.03
4684-0000-02	Tri: 4X6 Lamps: Stop & Tail, Amber w/Arrow, Backup - RH	**		4	310.03

\* Amp Draw is variable and application dependent

\*\* Refer to individual lamps

Part #	Description	AMP Draw		Std Cnt Qty	List Price - US Dollars
		12 V AMP	24 V AMP		
4684-0100-01	Tri: 4X6 Lamps: Stop & Tail, Amber w/Arrow, Backup w/Packard - LH	**		4	349.18
4684-0100-02	Tri: 4X6 Lamps: Stop & Tail, Amber w/Arrow, Backup w/Packard - RH	**		4	349.18
4684-0100-18	Tri: 4X6 Lamps: LED Stop & Tail, Amber Seq Turn, Backup w/Packard - LH	**	**	4	977.67
4684-0100-19	Tri: 4X6 Lamps: LED Stop & Tail, Amber Seq Turn, Backup w/Packard - RH	**	**	4	977.67
4684-0100-28	Tri: 4X6 Lamps: LED Stop & Tail, Amber Seq Turn, Incand Backup w/Packard - LH	**		4	678.23
4684-0100-29	Tri: 4X6 Lamps: LED Stop & Tail, Amber Seq Turn, Incand Backup w/Packard - RH	**		4	678.23
4684-0200-01	Tri: 4X6 Lamps: Stop & Tail, Amber w/Arrow, Backup w/Deutsch - LH	**		4	339.65
4684-0200-02	Tri: 4X6 Lamps: Stop & Tail, Amber w/Arrow, Backup w/Deutsch - RH	**		4	339.65
4684-0200-18	Tri: 4X6 Lamps: LED Stop & Tail, Amber Seq Turn, Backup w/Deutsch - LH	**	**	4	977.67
4684-0200-19	Tri: 4X6 Lamps: LED Stop & Tail, Amber Seq Turn, Backup w/Deutsch - RH	**	**	4	977.67
4684-0200-28	Tri: 4X6 Lamps: LED Stop & Tail, Amber Seq Turn, Incand Backup w/Deutsch - LH	**		4	694.10
4684-0200-29	Tri: 4X6 Lamps: LED Stop & Tail, Amber Seq Turn, Incand Backup w/Deutsch - RH	**		4	694.10
4684-LA2K	LED Seq Turn Kit, 4X6, 2 Lamps, Amber	**	**	1	399.96
4684-LC2K	LED Backup Kit, 4X6, 2 Lamps, Clear	**	**	1	718.44
4684-LR2K	LED Stop/Tail Kit, 4X6, 2 Lamps, Red	**	**	1	371.00
4694-0000-01	Quad: 4X6 Lamps: S, T, Arrow Turn, Backup, Blank - LH	**		4	371.00
4694-0000-02	Quad: 4X6 Lamps: S, T, Arrow Turn, Backup, Blank - RH	**		4	371.00
4694-0011-01	Quad: 4X6 Lamps, Red Warn Stop & Tail Amb Lt Bu	**		4	421.12
4694-0011-02	Quad 4X6 Lamps, Red Warn Stop & Tail Amb Rt Bu	**		4	421.12
4694-0171-18	Quad: 4X6 LED Warning-Red, Stop & Tail, Amber Seq Turn, Backup w/Packard - LH	**	**	4	1,328.94
4694-0171-19	Quad: 4X6 LED Lamps, Warning-Red, Stop & Tail, Amber Seq Turn, Backup w/Packard - RH	**	**	4	1,328.94
4694-0511-01	Quad: 4X6 Lamps, Red Warn Stop & Tail  Amb LH Bu D/D	**		4	434.87
4694-0511-02	Quad: 4X6 Lamps, Red Warn Stop & Tail  Amb RH Bu D/D	**		4	434.87
4694-0561-28	Quad: 4X6 Lamps, LED Stop & Tail, Amb Seq Turn, Incand Backup, LED Warn-Red W/(2)Deutsch-LH	**		4	1,004.12
4694-0561-29	Quad: 4X6 Lamps, LED Stop & Tail, Amb Seq Turn, Incand Backup, LED Warn-RedW/(2)Deutsch-RH	**		4	1,004.12
5000-1400-10	Marker, 1 Wire, #168, Red	0.35		240	7.76
5000-1400-20	Marker, 1 Wire, #168, Amber	0.35		240	7.76
5000-1406-10	Marker, 2 Wire, #168, Red	0.35		240	9.41
5000-1406-20	Marker, 2 Wire, #168, Amber	0.35		240	9.41
5001-0000-00	Gasket, Lens, 5000 Series			12	1.04
5002-0000-10	Lens for 5000/5120, Acrylic, Red			76	3.97
5002-0000-20	Lens for 5000/5120, Acrylic, Amber			76	3.97
5004-0001-00	Mounting Pad, 5000 Series			76	1.28
5006-0000-00	Shield for 5000 Lamp			144	3.59
5006-0001-00	Shield for 5000 Lamp, Black			144	3.59
5008-0000-00	Gasket, Shield, 5000 Series			12	1.04
5009-0000-00	Gasket, Lens, 5120 Series			12	1.28
5017-0000-00	Gasket, Lens, 5050 Series			12	1.28
5018-0000-00	Mounting Pad, 5050 Series			12	1.17
5020-0000-10	Lens, Acrylic, 5050 Series, Red			50	3.97
5020-0000-20	Lens, Acrylic, 5050 Series, Amber			50	3.97
5021-0000-10	Lens, Acrylic, 5051 Series, Red			12	4.23
5021-0000-20	Lens, Acrylic, 5051 Series, Amber			12	4.23
5024-0000-00	Gasket for Shield, 5050 Series			12	1.68
5024-0001-00	Gasket for Shield, 5050 Series			12	1.68
5025-0000-00	Shield for 5050 Lamp			144	3.85
5045-0100-10	Marker, #168 Flush Mount, Red	0.35		150	7.78
5045-0100-20	Marker, #168 Flush Mount, Amber	0.35		150	7.78
5045-7100-10	Marker, LED Flush Mount, Red	0.04		150	14.41
5045-7100-20	Marker, LED Flush Mount, Amber	0.04		150	14.41
5045-7110-20	Marker, LED Flush Mount 30 Deg Tilt Back, Amber	0.04		150	14.41
5050-1400-10	Marker, #168, Red	0.35		200	8.28

\* Amp Draw is variable and application dependent  
 \*\* Refer to individual lamps

Part #	Description	AMP Draw		Std Cnt Qty	List Price - US Dollars
		12 V AMP	24 V AMP		
5050-1400-20	Marker, #168, Amber	0.35		200	8.28
5050-1406-10	Marker, 2 Wire, #193, Red	0.35		198	10.01
5050-1406-20	Marker, 2 Wire, #193, Amber	0.35		198	10.01
5050-7000-10	LED Marker Lamp, Red	0.13		1	24.78
5050-7000-20	LED Marker Lamp, Amber	0.13		1	24.78
5051-1400-10	Marker, #168, Red	0.35		198	8.02
5051-1400-20	Marker, #168, Amber	0.35		198	8.02
5051-1406-10	Marker, 2 Wire, #193, Red	0.35		198	10.40
5051-1406-20	Marker, 2 Wire, #193, Amber	0.35		198	10.40
5060-1900-10	Marker, Incand #168, Red	0.35		200	8.77
5060-1900-20	Marker, Incand #168, Amber	0.35		200	8.77
5060-7000-10	LED, Cab Marker Light, Red	0.3		200	10.30
5060-7000-20	LED, Cab Marker Light, Amber	0.3		200	10.30
5102-0000-00	Mounting Pad, 5120 Series			50	1.18
5120-1300-10	Marker w/Shield 2 Bulb/1 Wire Red	0.7		126	16.04
5120-1300-20	Marker w/Shield 2 Bulb/1 Wire Amber	0.7		126	16.04
5120-1306-10	Marker w/Shield 2 Bulb/2 Wire Red	0.7		126	17.91
5120-1306-20	Marker w/Shield 2 Bulb/2 Wire Amber	0.7		126	17.91
5150-0100-10	Marker, Incand, No Plug, Red	0.35		200	8.02
5150-0100-20	Marker, Incand, No Plug, Amber	0.35		200	8.02
5150-0110-10	Marker, Incand, w/Plug & Wires, Red	0.35		200	13.82
5150-0110-20	Marker, Incand, w/Plug & Wires, Amber	0.35		200	13.82
5180-0100-10	LED Marker Lamp, Econ. No Plug, Red	0.04		200	16.40
5180-0100-20	LED Marker Lamp, Econ. No Plug, Amber	0.04		200	16.40
5180-0110-10	LED Marker Lamp, Econ. w/Plug, Red	0.04		200	22.07
5180-0110-20	LED Marker Lamp, Econ. w/Plug, Amber	0.04		200	22.07
5210-1000-10	LED Marker Lamp, Red LED/Lens, Grmt Mt.	0.05		100	11.23
5210-1000-20	LED Marker Lamp, Amber LED/Lens, Grmt Mt.	0.05		100	11.23
5210-1000-30	LED Marker Lamp, Clear LED/Lens, Grmt Mt.	0.02		100	15.60
5210-1000-40	LED Marker Lamp, Blue LED/Lens, Grmt Mt.	0.02		100	15.60
5210-1000-70	LED Marker Lamp, Green LED/Lens, Grmt Mt.	0.02		100	15.60
5211-1000-10	LED Marker Lamp, Red LED, Clear Lens, Grmt Mt.	0.05		100	11.23
5211-1000-20	LED Marker Lamp, Amber LED, Clear Lens, Grmt Mt.	0.05		100	11.23
5211-1000-40	LED Marker Lamp, Blue LED, Clear Lens, Grmt Mt.	0.02		100	15.60
5211-1000-70	LED Marker Lamp, Green LED, Clear Lens, Grmt Mt.	0.02		100	15.60

\* Amp Draw is variable and application dependent  
 \*\* Refer to individual lamps



**Part #**
**Description**
**AMP Draw**  
**12 V AMP    24 V AMP**
**Std Cnt**  
**Qty**
**List Price -**  
**US Dollars**

Part #	Description	12 V AMP	24 V AMP	Std Cnt Qty	List Price - US Dollars
6000-0000-04	V-MUX Hercules Node	*	*	1	1,683.00
6000-0001-04	V-MUX Hercules Node, High Voltage	*		1	1,683.00
6010-0000-00	V-MUX Mini Node	*		1	986.00
6020-0000-00	Input Module, V-MUX, 16 Input	*	*	1	869.00
6020-0000-01	Input Module, V-MUX, 16 Input, High Voltage	*	*	1	869.00
6030-0000-00	V-MUX 8X16 Node	*	*	1	1,049.00
6030-0000-01	V-MUX 8X16 Node, High Voltage	*	*	1	1,049.00
6060-0000-00	V-MUX High Content Hercules HC Node	*	*	1	1,395.00
6111-0000-00	Transceiver, USB, (Bustool) V-MUX	*		1	869.00
6120-0000-00	Modem Module (Transceiver) V-MUX	*	*	1	696.00
6131-0000-00	Kit, Diagnostics - USB w/Downloader	*		1	1,485.00
6151-0000-00	Kit, OEM USB +: Sys_Des+Diag+Dwnldr	*		1	6,671.00
6204-0000-00	Occupant Restraint Indicator	*	*	1	603.22
6204-0000-01	Truck Cab Seatbelt Indicator - Digital Backlight	*	*	1	603.22
6204-0014-00	Amb Seat Ind w/Door Ajar - Analog Backlight	*	*	1	603.22
6204-0014-01	Amb Seat Ind w/Door Ajar - Digital Backlight	*	*	1	603.22
6204-0024-00	Amb Seat Ind - Analog Backlight	*	*	1	603.22
6204-0024-01	Amb Seat Ind with Digital Backlight	*	*	1	603.22
6241-0010-00	V-MUX Vista IV Interface Module/Display Panel Mount	*	*	1	2,948.00
6241-0011-00	V-MUX Vista IV Interface Module/Display 6" Arm Mount	*	*	1	3,010.00
6241-0110-00	Vista IV Display with Touch Screen	*	*	1	3,242.00
6241-0111-00	Vista IV Display with Touch Screen, 6" Arm Mount	*	*	1	3,305.00
6241-0130-00	Vista IV Touch, Bezel, Panel Mount	*	*	1	2,948.00
6241-0144-01	Vista IV Touch, DIN Kit, Dash Mount, Ford F150-550	*	*	1	3,031.00
6241-0144-02	Vista IV Touch, DIN Kit, Dash Mount, Chevy Van/Pickup	*	*	1	3,031.00
6242-0010-00	Vista IV Display, 6" Video Pigtail	*	*	1	2,981.00
6242-0011-00	Vista IV Display, 6" Arm Mount, 6" Video Pigtail	*	*	1	3,044.00
6242-0110-00	Vista IV Display with Touch Screen, 6" Video Pigtail	*	*	1	3,276.00
6242-0111-00	Vista IV Display with Touch, 6" Arm Mount, 6" Pigtail	*	*	1	3,338.00
6242-0144-01	Vista IV Touch, DIN Kit, Dash Mount, 6" Video, Ford F150-550	*	*	1	3,031.00
6242-0144-02	Vista IV Touch, DIN Kit, Dash Mount, 6" Video, Chevy Van/Pickup	*	*	1	3,031.00
6243-0010-00	Vista IV Display, 10" Video Pigtail	*	*	1	2,989.00
6243-0011-00	Vista IV Display, 6" Arm Mount, 10" Video Pigtail	*	*	1	3,048.00
6243-0110-00	Vista IV Display with Touch Screen, 10" Video Pigtail	*	*	1	3,280.00
6243-0111-00	Vista IV Display with Touch, 6" Arm Mount, 10" Pigtail	*	*	1	3,342.00
6300-0400-00	Panel, Four Position	*	*	1	388.00
6300-0800-00	Panel, Eight Position	*	*	1	642.00
6310-0000-12	12V Smart Switch Controller	*		1	446.00
6310-0000-24	24V Smart Switch Controller		*	1	446.00
6311-0300-00	3-Key Smart Switch Module	*	*	1	196.00
6311-0400-00	4-Key Smart Switch Module	*	*	1	222.00
6409-0000-01	Link2 Subscription 1 Year Renewal				299.00
6409-0000-02	Link2 Subscription 2 Year Renewal				508.00
6409-0000-05	Link2 Subscription 5 Year Renewal				1,121.00
6410-0000-01	Link2 Module Only w/1 yr Subscription				1,844.00
6410-0000-02	Link2 Module Only w/2 yr Subscription				2,053.00
6410-0000-05	Link2 Module Only w/5 yr Subscription				2,667.00

\* Amp Draw is variable and application dependent  
 \*\* Refer to individual lamps

Part #	Description	AMP Draw		Std Cnt Qty	List Price - US Dollars
		12 V AMP	24 V AMP		
6410-0000-91	Link2 Bundle Kit w/1 yr Subscription				1,895.00
6410-0000-92	Link2 Bundle Kit w/2 yr Subscription				2,103.00
6410-0000-95	Link2 Bundle Kit w/5 yr Subscription				2,717.00
6444-0000-00	Vehicle Data Recorder	*	*	1	905.00
6444-0100-00	Vehicle Data Recorder, 2 Seat				905.00
6444-0101-00	Vehicle Data Recorder, 3 Seat				905.00
6444-0102-00	Vehicle Data Recorder, 5 Seat				905.00
6444-0103-00	Vehicle Data Recorder, 6 Seat				905.00
6444-0106-00	Vehicle Data Recorder, 4 Seat				905.00
6500-0000-00	Camera, White, Color Video Out, R View w/Bracket	*		1	553.00
6500-0000-01	Camera, Black, Color Video Out, R View w/Bracket	*		1	553.00
6501-0000-00	Camera, B/W Video Out, Left, White	*		1	351.00
6502-0000-00	Camera, B/W Video Out, Right, White	*		1	351.00
6503-0000-00	Camera, B/W Video Out, Left, Chrome	*		1	351.00
6504-0000-00	Camera, B/W Video Out, Right, Chrome	*		1	351.00
6505-0000-00	Camera, B/W Video Out, Left, Primer	*		1	351.00
6506-0000-00	Camera, B/W Video Out, Right, Primer	*		1	351.00
6507-0000-00	Camera Kit, Color, Rear, 12/24V Black	*		1	553.00
6555-0000-00	Navigation GPS			1	1,054.00
OJ50-1505-01	Mounting Bracket for Vista, Swivel, 6"			1	89.29
OK00-2065-00	Mounting Flange, DT04-4P			1	2.11
OK14-2057-00	Plug 3 Pos Sealed, DT06 WP032 Mod			1	10.83
OK14-2070-00	Plug, 12 Contact, Size 20, Key "A"			1	12.14
OK14-2071-00	Plug, 12 Contact, Size 20, Key "B"			1	15.27
OK14-2654-00	Plug, 6 Pos, Size 20, DTM06-6S			1	1.24
OK15-1436-00	Receptacle, 4 Pos, Deutsch, DT04			1	4.55
OK18-1438-00	Lock, Wedge, 4 Pos, w/Deutsch Receptacle			1	0.51
OK18-2058-00	Lock, Wedge, Keyed, 3 Pos, Green			1	0.64
OK15-2056-00	Receptacle, 3 Pos, 3 Way "Y" W/P007 Mod			1	23.75
OK18-2059-00	Lock, Wedge, Keyed, 3 Pos, Blue			1	0.73
OK18-2072-00	Lock, Wedge, 12 Contact Plug			1	0.52
OK18-2654-00	Lock, Wedge, 6 Pos, WM-6S			1	1.19
OK20-0837-00	Terminal, Pin, 16-18 AWG Deutsch			1	0.68
OK20-0852-00	Terminal, Pin, 16 AWG Deutsch			1	0.78
OK20-2063-00	Terminal, 20 GA. Pin, 20/24 GA Wire			1	1.28
OK21-1001-00	Terminal, Socket, 16-18 AWG Deutsch			1	0.91
OK21-2062-00	Terminal, 20 GA Socket, 20/24 GA Wire			1	1.17
OK21-2074-00	Terminal, Wire Crimp (for OK14-2073-00)			1	0.65
OK90-2056-00	V-MUX Connector Kit, Communications			1	61.86
OK90-2280-00	Connector Kit V-MUX, Hercules - 6000-0000-04			1	136.69
OK90-2281-00	Connector Kit V-MUX, 4X12 - 6010-0000-00			1	78.48
OK90-2282-00	Connector Kit V-MUX, 16 Input - 6020-0000-00			1	55.70
OK90-2283-00	Connector Kit V-MUX, Gateway - 6400-0000-01			1	19.03
OK90-2286-00	Connector Kit V-MUX, 8X16 - 6030-0000-00			1	94.11
OK90-2310-00	Connector Kit V-MUX, Vista - 6231-0010-XX			1	10.41
OK90-2311-00	Connector Kit V-MUX, PODS - 6310-0000-12/24			1	163.59
OK90-2311-01	Connector Kit Deutsch, PODS CNTRLR, 16"			1	159.46
OK90-2763-00	Connector Kit V-MUX, Climate Control 0N70-1519			1	52.50
OK90-2782-00	Connector Kit V-MUX, Occupant Restraint Ind. 6204			1	23.05
OK90-3462-00	Hercules HCN Connector Kit			1	155.00
OL20-1043-00	Cable, Troubleshoot Herc Outputs, V-MUX			1	61.81

\* Amp Draw is variable and application dependent  
 \*\* Refer to individual lamps

Part #	Description	AMP Draw		Std Cnt Qty	List Price - US Dollars
		12 V AMP	24 V AMP		
0L20-1600-13	V-MUX Communications Wire, 1,000 Ft.			1	1,300.08
0L20-1600-22	V-MUX Communications Wire, 200 Ft.			1	267.18
0L20-1600-51	V-MUX Communications Wire, 50 Ft.			1	66.57
0L20-1600-52	V-MUX Communications Wire, Ft. feet			1	666.87
0L20-1793-00	Cable Kit, Male RCA, 25 Ft. w/Adapter			1	55.13
0L20-1793-01	Cable Kit, Male RCA, 50 Ft. w/Adapter			1	81.02
0L20-2084-01	Cable, Male/Male RCA, 50 Ft.			1	74.53
0L20-2084-02	Cable, Male/Male RCA, 75 Ft.			1	97.47
0L20-2084-03	Cable, Male/Male RCA, 100 Ft.			1	133.60
0L40-1635-00	Cable, One On One for 4X12, 16X0, V-MUX			1	85.28
0L40-2020-00	Smart Switch Cable Assembly			1	43.20
0L40-2032-00	25 FT Shielded Cable for Camera Kit			1	70.67
0L40-2088-00	Controller Cable Assembly for V-MUX PODS 10 Ft.			1	114.67
0L40-2355-00	Harness, Hall Effect Sensor			1	16.07
0L40-2597-00	VDR Download Harness			1	54.00
0L40-2677-00	Modem Harness			1	57.23
0L40-2776-00	Adapter Harness			1	277.34
0L40-2806-00	Video Pigtail (4 RCA Jacks) 6" long			1	62.50
0L40-2806-01	Video Pigtail (4 RCA Jacks) 10" long			1	65.90
0L40-3312-00	LINK2 J1939 Remount Harness			1	130.00
0L40-3331-00	Cable, Extension, RP-SMA, 10 Ft.			1	40.00
0L80-1258-00	Cable, RS485 Transceiver to V-MUX			1	14.32
0L80-1259-00	Cable, Troubleshoot Mini Node Outputs, V-MUX			1	14.32
0L80-1960-00	MOV Kit, Hercules Field Service			1	12.89
0L80-2653-00	Kit, Wire & Connector, VDR & SBI Installation			1	134.80
0N30-2392-00	Vista III Touch Screen			1	3,375.35
0N70-1519-03	Climate Controller, Fahrenheit			1	643.03
0N70-1519-04	Climate Controller, Celsius			1	643.03
0Q20-1736-00	V-MUX Legend Sheet, 88 Per Sheet			1	22.84
0Q20-2972-07	Label, Extended Warranty, 7 Year			1	214.60
0Q20-2972-10	Label, Extended Warranty, 10 Year			1	378.67
0R00-2306-00	V-MUX Hall Effect Current Sensor			1	506.99
0R10-3031-00	Transmitter, Delivery Pressure 0-500 PSI			1	414.66
0R10-3032-00	Transmitter, Compound Pressure 14.7-500 PSI			1	381.70
0R11-3035-00	Snubber, Pressure Transducer, SS, 1/4			1	57.34
0R13-0614-00	V-MUX Temperature Sensor			1	67.59
0R62-2795-01	50 Amp Breaker			1	214.71
0R62-2795-02	100 Amp Breaker			1	214.71
0R62-2795-03	150 Amp Breaker			1	229.03
0R80-0615-00	Obsolete - order 0R00-2306-00			--	--
0U10-0715-00	Display, Vacuum Florescent			1	412.33

7000-0000-01	Flasher, 8-Lamp	*		40	129.99
7000-1000-00	Flasher, 8-Lamp, Modular	*		40	142.96
7110-0000-30	Strobe Beacon, Class 2, White			12	89.86
7110-0100-30	Strobe Beacon, Class 2, White w/Packard			12	100.89
7150-6550-10	Strobe, 7/10J, Low-Pro, Poly Base, Red	1.3		1	218.41
7150-6550-20	Strobe, 7/10J, Low-Pro, Poly Base, Amber	1.3		1	218.41
7150-6550-30	Strobe, 7/10J, Low-Pro, Poly Base, Clear	1.3		1	218.41
7150-6570-10	Strobe, 7/10J, High, Poly Base, Red	1.3		1	220.48

\* Amp Draw is variable and application dependent  
 \*\* Refer to individual lamps

Part #	Description	AMP Draw		Std Cnt Qty	List Price - US Dollars
		12 V AMP	24 V AMP		
7150-6570-20	Strobe, 7/10J, High, Poly Base, Amber	1.3		1	220.48
7150-6570-30	Strobe, 7/10J, High, Poly Base, Clear	1.3		1	220.48
7150-6640-10	Strobe, 8/12J, Low-Pro, Die Cast, Red	1.3		1	252.41
7150-6640-20	Strobe, 8/12J, Low-Pro, Die Cast, Amber	1.3		1	252.41
7150-6640-30	Strobe, 8/12J, Low-Pro, Die Cast, Clear	1.3		1	252.41
7150-6660-10	Strobe, 8/12J, Hi-Pro, Die Cast, Red	1.3		1	264.77
7150-6660-20	Strobe, 8/12J, Hi-Pro, Die Cast, Amber	1.3		1	264.77
7150-6660-30	Strobe, 8/12J, Hi-Pro, Die Cast, Clear	1.3		1	264.77
7150-6840-10	Strobe, 12/16J, Low-Pro, Die Cast, Red	2.0/4.0	3.0 Max	1	314.22
7150-6840-20	Strobe, 12/16J, Low-Pro, Die Cast, Amber	2.0/4.0	3.0 Max	1	314.22
7150-6840-30	Strobe, 12/16J, Low-Pro, Die Cast, Clear	2.0/4.0	3.0 Max	1	314.22
7150-6860-10	Strobe, 12/16J, Hi-Pro, Die Cast, Red	2.0/4.0	3.0 Max	1	314.22
7150-6860-20	Strobe, 12/16J, Hi-Pro, Die Cast, Amber	2.0/4.0	3.0 Max	1	314.22
7150-6860-30	Strobe, 12/16J, Hi-Pro, Die Cast, Clear	2.0/4.0	3.0 Max	1	314.22
7150-6880-30	Strobe, 12/16J, Hi-Pro, Die Cast, Clear	2.0/4.0	3.0 Max	1	314.22
7150-7160-10	LED Beacon, Red, Class I			1	758.26
7150-7160-20	LED Beacon, Amber, Class I			1	758.26
7150-7160-30	LED Beacon, White, Class I			1	758.26
7150-7160-40	LED Beacon, Blue, Class I			1	758.26
7150-7160-50	LED Beacon, Green, Class I			1	758.26
7301-0000-00	Flasher, Ambulance, Solid State	*		10	171.62
7404-0060-00	Strobe Pack, 4-Channel 60W	*		10	387.38
7414-0090-00	Strobe Pack, 4-Channel 90W	*		10	464.64
7701-0000-00	Flasher/Controller for LED, Solid State	*		10	114.07
7811-0000-10	Warning 7X9, Halogen #795X, Panel, Red	4.2		6	62.50
7811-0000-20	Warning 7X9, Halogen #795X, Panel, Amber	4.2		6	62.50
7811-0000-30	Warning 7X9, Halogen #795X, Panel, Clear	4.2		6	62.50
7811-0000-33	Scene 7X9, Halogen #886, Panel, Clear	3.9		6	66.54
7811-0000-40	Warning 7X9, Halogen #795X, Panel, Blue	5		6	62.50
7812-0000-10	Warning 7X9, Halogen #795X, Bezel, Red	4.2		6	87.95
7812-0000-20	Warning 7X9, Halogen #795X, Bezel, Amber	4.2		6	87.95
7812-0000-30	Warning 7X9, Halogen #795X, Bezel, Clear	4.2		6	87.95
7812-0000-33	Scene 7X9, Halogen #886, Bezel, Clear	3.9		6	93.05
7812-0000-40	Warning 7X9, Halogen #795X, Bezel, Blue	4.2		6	87.95
7821-0000-10	Strobe, Warning 7X9, Panel, Red	*	*	6	109.09
7821-0000-20	Strobe, Warning 7X9, Panel, Amber	*	*	6	109.09
7821-0000-30	Strobe, Warning 7X9, Panel, Clear	*	*	6	109.09
7821-0000-40	Strobe, Warning 7X9, Panel, Blue	*	*	6	109.09
7822-0000-10	Strobe, Warning 7X9, Bezel, Red	*	*	6	135.59
7822-0000-20	Strobe, Warning 7X9, Bezel, Amber	*	*	6	135.59
7822-0000-30	Strobe, Warning 7X9, Bezel, Clear	*	*	6	135.59
7822-0000-40	Strobe, Warning 7X9, Bezel, Blue	*	*	6	135.59
7841-0000-10	Stop or Tail, 7X9, Panel, #1156, Red	2.1		6	59.52
7841-0000-20	Turn, 7X9, Panel, #1156, Amber	2.1		6	59.52
7841-0000-21	Turn, 7X9, LH w/Arrow LH, Panel, #1156, Amber	2.1		6	67.81
7841-0000-22	Turn, 7X9, RH w/Arrow, Panel, #1156, Amber	2.1		6	67.81
7841-0000-30	Backup, 7800 Series, Panel, #1156, Clear	2.1		6	59.53
7842-0000-10	Stop or Tail, 7X9, Bezel, #1156, Red	2.1		6	85.10
7842-0000-20	Turn, 7X9, Bezel, #1156, Amber	2.1		6	85.10
7842-0000-21	Turn, 7X9, LH w/Arrow LH, Bezel, #1156, Amber	2.1		6	94.45
7842-0000-22	Turn, 7X9, RH w/Arrow, Bezel, #1156, Amber	2.1		6	94.45
7842-0000-30	Backup, 7800 Series, Bezel, #1156, Clear	2.1		6	85.10
7851-0000-10	Stop & Tail, 7X9, Panel, #1157, Red	2.1/0.59		6	63.89

\* Amp Draw is variable and application dependent  
 \*\* Refer to individual lamps

Part #	Description	AMP Draw		Std Cnt Qty	List Price - US Dollars
		12 V AMP	24 V AMP		
7851-0000-20	Turn & Park, 7X9, Panel, #1157, Amber	2.1/0.59		6	90.40
7852-0000-10	Stop & Tail, 7X9, Bezel, #1157, Red	2.1/0.59		6	90.40
7852-0000-20	Turn & Park, 7X9, Bezel, #1157, Amber	2.1/0.59		6	90.40
7862-0000-33	HID Scene Lamp, 7800, Bezel, Clear	2.6		6	624.55
7862-0000-3K	HID Scene Kit, 7X9, 2 Lamps, Clear	**		1	1,185.66
7871-1000-10	LED, Warning, 7X9, Panel, Red	2.3	1.18	6	515.56
7871-1000-20	LED, Warning, 7X9, Panel, Amber	2.3	1.18	6	515.56
7871-1000-30	LED, Warning, 7X9, Panel, Clear	2.3	1.18	6	1,170.11
7871-1000-40	LED, Warning, 7X9, Panel, Blue	2.3	1.18	6	1,170.11
7872-1000-10	LED, Warning, 7X9, Bezel, Red	2.3	1.18	6	536.30
7872-1000-20	LED, Warning, 7X9, Bezel, Amber	2.3	1.18	6	536.30
7872-1000-30	LED, Warning, 7X9, Bezel, Clear	2.3	1.18	6	1,212.64
7872-1000-40	LED, Warning, 7X9, Bezel, Blue	2.3	1.18	6	1,212.64
8004-0000-30	Lens, Dome, 8005 Series, Clear			200	2.52
8005-1000-30	Dome, #93, 15 CP, Clear	1.1		200	8.00
8005-1006-30	Dome, Grd Wire, #93, 15 CP, Clear	1.1		200	9.92
8005-1010-30	Dome, #90, DC, Clear	0.4		200	12.65
8005-9200-30	Dome, #1004, DC, Clear	1		200	12.65
8010-1600-30	Dome, #921, Sgl Wire, Chrome, 21 CP, Clear	1.4		36	35.95
8010-1608-30	Dome, Two-Wire, #921, Chrome, 21 CP, Clear	1.4		36	41.00
8013-0000-30	Lens, Deluxe Dome, 8010 Series, Clear	0.6		120	7.12
8015-1090-30	Dome, #89, 6 CP, Clear	0.6		36	8.57
8020-0001-30	Dome, Snap-In, #906, 6 CP, Clear	0.7		100	9.74
8020-0003-30	Dome, Snap-In, Amp, #906, 6 CP	0.7		100	9.74
8020-0101-30	Dome, Snap-In, #912, 12 CP, Clear	1		100	9.74
8020-0103-30	Dome, Snap-In, Amp, #912, 12 CP, Clear	1		100	9.74
8020-0191-30	Dome, Snap-In, Delphi conn, 12 CP #912 bulb w/pads	1		100	10.04
8020-0201-30	Dome, Snap-In, #922, 15 CP, Clear	1		100	9.74
8020-7000-30	Dome, Snap-In LED, Clear	0.26		24	42.11
8020-7091-30	Dome, Snap-In LED, Clear	0.26		24	45.04
8021-0000-10	Lens, Acrylic, Red			12	4.08
8021-0000-30	Lens, Acrylic, Clear			12	4.08
8024-0000-00	Gasket, Lens,			12	1.06
8024-0001-00	Mounting Pad, 8025 Series			12	1.06
8025-1400-30	Stepwell, #89, 6 CP, Clear	0.6		100	8.53
8025-1490-30	Stepwell, #68 DC, Non-Ind, Clear	0.6		100	10.84
8025-9100-30	Stepwell w/Boot, #89, Clear	0.6		100	9.70
8025-9100-32	Step Lamp w/Boot, 6 CP, Clear, w/Deutsch, Clear	0.6		100	13.67
8026-0000-10	Utility, #67, Clear	0.6		100	14.32
8026-1490-10	Emergency Door, #68, DC, Red	0.6		100	10.84
8035-1400-30	Stepwell, 15 CP, #1003 bulb, clear, single wire	0.94		100	13.06
8035-1490-30	Stepwell, 15 CP, #1004 bulb, clear, w/ground wire	0.94		100	13.69
8040-0500-80	Dome, #1156, Incand, Clear, Stainless Steel, Rec. Mt.	2.1		32	22.41
8040-0520-80	Dome, Df, Hi/Lo Clear, Stainless Steel, Rec. Mt.	2.1/0.59		32	22.41
8046-0300-80	Dome - Hal, GH9 Bulb, SF, Clear, Stainless Steel, Rec. Mt.	2.9		32	26.40
8046-0320-80	Dome, Hal GH9 Bulb/Inc. 906 Bulb, Clear, SS, Rec. Mt.	2.9/0.69		32	33.04
8047-1000-10	Dome, V-LED Upgradeable, Red Hi/Lo Surface Mt.	0.65/0.05		8	223.22
8047-1000-30	Dome, V-LED Upgradeable, Clear Hi/Lo Surface Mt.	0.85/0.06		8	223.22
8049-0000-10	Dome, V-LED Upgradeable, Red, Hi/Lo, SS body, Rec. Mt.	0.65/0.05		8	234.81
8049-0000-30	Dome, V-LED Upgradeable, Clear, Hi/Lo, SS body, Rec. Mt.	0.85/0.06		8	234.81
8049-0001-10	Dome, V-LED Upgradeable, Red, Hi/Lo, Wh body, Rec. Mt.	0.65/0.05		8	234.81
8049-0001-30	Dome, V-LED Upgradeable, Clear, Hi/Lo, Wh body, Rec. Mt.	0.85/0.06		8	234.81

\* Amp Draw is variable and application dependent

\*\* Refer to individual lamps



Part #	Description	AMP Draw		Std Cnt Qty	List Price - US Dollars
		12 V AMP	24 V AMP		
8051-0000-30	Recessed Low Profile Interior Dome Lamp	0.5/0.21	0.25/0.9	12	131.82
8080-0000-13	Dual Bulb Dome, Ground Sw, Bk Bezel, Red/Clr	2		60	60.69
8080-1000-13	Dual Bulb Dome, +Batt Sw, Bk Bezel, Red/Clr	2		60	60.69
8080-7000-13	Dual LED Dome, Ground Sw, Bk Bezel, Red/Clr	0.04		60	103.43
8080-8000-13	Dual LED Dome, +Batt Sw, Bk Bezel, Red/Clr	0.04		60	103.43
8081-0000-13	Dual Bulb Dome, Ground Sw, Grey Bezel, Red/Clr	2		60	60.69
8081-1000-13	Dual Bulb Dome, +Batt Sw, Bk Grey, Red/Clr	2		60	60.69
8081-7000-13	Dual LED Dome, Ground Sw, Bk Grey, Red/Clr	0.04		60	103.43
8081-8000-13	Dual LED Dome, +Batt Sw, Bk Grey, Red/Clr	0.04		60	103.43
8086-6978-68	Dome w/Push Buttons, Red/Clear	0.9		60	66.05
8101-0100-30	License Lamp, #168, 3 CP, Clear	0.35		100	9.27
8102-0100-30	License Lamp, LED, Clear	0.1		100	21.75
8220-0100-30	Cab Dome Lamp	0.3		24	32.69
8250-0100-30	LED Swivel Reading Lamp, Gray	0.1		50	20.64
8270-0100-30	LED Work Lamp, Delphi Conn	0.18		50	26.46
8280-0100-30	Accent Lamp w/Switch	.07		50	13.15
8401-0000-20	LED Door Warning Light Strip, Amber Arrow	0.09		100	85.28
9018-0001-00	Bulb: S Beam, #4436, 35W	2.75		48	17.38
9018-0006-00	Bulb: S Beam, #4636, 80W	5.75		48	17.38
9018-0012-00	Bulb, #93, Incand, SC, 15 CP	1.1		100	2.11
9018-0013-00	Bulb, #1156, Incand, 32 CP	2.1		100	2.11
9018-0014-00	Bulb, #67, Incand, SC, 4 CP	0.6		100	2.11
9018-0016-00	Bulb, #89, Incand, SC, 6 CP	0.6		100	2.11
9018-0017-00	Bulb, #1895, Incand, Mini, 2 CP	0.27		100	2.11
9018-0019-00	Bulb, #1141, Incand, 21 CP	1.9		100	2.11
9018-0020-00	Bulb, #1157, Incand, DC, 32/3 CP	2.1/0.59		100	2.11
9018-0021-00	Bulb, #2357, Incand, DC, 40/3 CP	2.2/0.59		100	2.11
9018-0022-00	Bulb, #3497, Incand, SC, 45 CP	2.1		100	6.99
9018-0023-00	Bulb, #68, Incand, 6 CP	0.06		100	2.10
9018-0025-00	Bulb, #1076, Incand, DC, 32 CP	2.1		100	2.10
9018-0027-00	Bulb, #1295, Incand, SC, 37 CP	2.9		100	5.65
9018-0030-00	Bulb, #1004, Incand, DC, 15 CP	1		100	2.10
9018-0031-00	Bulb, S Beam, #H7635, 50W	4.2		48	31.99
9018-0032-00	Bulb, #168, Incand, 3 CP	0.35		100	2.11
9018-0034-00	Bulb, #GH9, Mini Hal, 37.5W, 64 CP	2.9		100	8.54
9018-0035-00	Bulb, #906, Incand, 6 CP	0.69		100	2.11
9018-0036-00	Bulb, #921, Incand, 21 CP	1.4		100	2.10
9018-0037-00	Bulb, #GH22, Hal, 27W, 35 CP	2.1		100	20.39
9018-0039-00	Bulb, #3156, Incand, 32 CP	2.1		100	2.11
9018-0040-00	Bulb, #3157, Incand, DC, 32/3 CP	2.2		100	2.11
9018-0042-00	Bulb, #1142, Incand, DC, 21 CP	1.9		100	2.10
9018-0047-00	Bulb, #193, Incand, 2 CP	0.35		100	2.11
9018-0049-00	Bulb, #90, Incand, 6 CP	0.4		100	3.97
9018-0051-00	Bulb, #1638, Incand, 24V 32 CP		1.01	100	19.48
9185-40003-3	Utility/Dome Light Kit	1.4		50	12.23
9185-40034	Utility/Dome Light Kit - Sealed Terminals	1.4		50	18.69
9186-0320-A	Reflector, 3" Armored, Amber			100	4.50
9186-0320-R	Reflector, 3" Armored, Red			100	4.50
9186-038B-A	Reflector, 3" Plastic, Amber			100	2.33
9186-038B-R	Reflector, 3" Plastic, Red			100	2.33
9186-0385-A	Reflector, 3" Stick-On, Amber			100	1.93

\* Amp Draw is variable and application dependent  
 \*\* Refer to individual lamps

Part #	Description	AMP Draw		Std Cnt Qty	List Price - US Dollars
		12 V AMP	24 V AMP		
9186-0385-R	Reflector, 3" Stick-On, Red			100	1.82
9186-068P-A	Reflector, 3" Center-Mount, Amber			100	1.93
9186-068P-R	Reflector, 3" Center-Mount, Red			100	1.93
9186-0785-R	Reflector, Oblong, Red			100	2.18
9186-099B-A	Reflector, Rectangular, Bezel, Amber			100	2.57
9186-099B-R	Reflector, Rectangular, Bezel, Red			100	2.57
9186-099S-A	Reflector, Rectangular, Amber			100	2.05
9186-099S-R	Reflector, Rectangular, Red			100	2.05
9186-1500-10	LED Clearance/Marker, Red	0.05		50	13.60
9186-1500-20	LED Clearance/Marker, Amber	0.05		50	13.60
9186-1501-30	LED Utility Lamp, White	0.05		50	30.04
9186-1501-40	LED Utility Lamp, Blue	0.05		50	30.04
9186-1501-50	LED Utility Lamp, Green	0.05		50	30.04
9186-1585-10	LED Truck Style Marker Lamp, Red	0.03		200	11.63
9186-1585-20	LED Truck Style Marker Lamp, Amber	0.03		200	11.63
9186-2300-10	LED Courtesy, Black, Red	0.025		50	19.72
9186-2300-20	LED Courtesy, Black Base, Amber	0.025		50	19.72
9186-2300-30	LED Courtesy, Black Base, Clear	0.025		50	32.37
9186-2300-40	LED Courtesy, Black Base, Blue	0.025		50	32.37
9186-2300-50	LED Courtesy, Black Base, Green	0.025		50	32.37
9186-2301-10	LED Courtesy, Chrome, Red	0.025		50	22.52
9186-2301-20	LED Courtesy, Chrome, Amber	0.025		50	22.52
9186-2301-30	LED Courtesy, Chrome, Clear	0.025		50	35.18
9186-2301-40	LED Courtesy, Chrome, Blue	0.025		50	35.18
9186-2301-50	LED Courtesy, Chrome, Green	0.025		50	35.18
9186-2366-10	LED Dual Face Outrigger Lamp Red/Red	0.7		12	69.38
9186-23882-2540	Mounting Pad, 9186-23882 Series			12	4.17
9186-23882-30	Stepwell & Utility, #906, Clear	0.7		100	19.43
9186-23882-32	Step/Licnse, #906, 2-Pin Deutsch, Clear	0.7		100	25.21
9186-4570-30	Backup, Black Bezel, 1 Wire, #1156, Clear	2.1		100	7.27
9186-4570-31	Backup, Black Bezel, 1 Wire w/Con, #1156, Clear	2.1		100	9.90
9186-4571-30	Backup, Black Bezel, 2 Wire, #1076, Clear	2.1		100	8.65
9186-4571-31	Backup, Black Bezel, 2 Wire w/Con, #1076, Clear	2.1		100	11.27
9186-5300-10	4" Stop & Tail, Grommet Mount, Red	2.9/0.6		50	12.44
9186-5301KC	4" Backup Kit, Grommet Mt, bonded wire Metripak, Clear			50	10.95
9186-5301KR	4" Stop.Tail Kit, Grommet Mt, bonded wire Metripak, Clear			50	17.63
9186-5442-10	LED Stop/Tail Lamp w/License	0.23/0.08		50	39.35
9186-5443-10	LED Stop/Tail Lamp No License, No Studs	0.23/0.08		50	39.35
9186-5444-10	LED Stop/Tail Lamp w/License, No Studs	0.23/0.08		50	39.35
9186-5515-31	4" Backup, Flange Mt, 2-Wire Metripak Con., Clear	0.34		50	106.55
9186-5525-10	LED Stop/Tail, 4", 3 Wire, Grommet Mt, Red	0.3/0.1		10	37.26
9186-5525-20	LED Park/Turn, 4", 3 Wire, Grommet Mt, Amber	0.3/0.1		10	37.26
9186-5526-30	LED Backup, 4", Grommet Mt, Clear	0.34		50	90.67
9186-5526KC	LED Interior/Comp Kit, 4", Con, Clear	0.34		10	92.76
9186-5585-10	7" LED, Stop & Tail w/Reflex, Red	0.54/0.03		12	57.92
9186-5585-20	7" LED, Park/Turn w/Reflex, Amber	0.54/0.03		12	57.92
9186-5586-10	7" LED, Stop & Tail, Red	0.54/0.03		12	57.92
9186-5586-20	7" LED, Park/Turn, Amber	0.54/0.03		12	57.92
9186-5586-30	7" LED Backup, Clear	0.26		12	93.30

\* Amp Draw is variable and application dependent  
 \*\* Refer to individual lamps

**NOTES:**

Part #	Description	AMP Draw		Std Cnt Qty	List Price - US Dollars
		12 V AMP	24 V AMP		
9186-758	Flourescent, Single Tube, 8 W	0.5		50	23.98
9186-759	Flourescent, Dual Tube, 16 W	1.3		50	37.16
9186-8560-29	Turn Signal-Side/Marker w/Grnd Tab, Amber	2.1/0.59		50	21.76
9186-8562-30	Stepwell, Single Wire, #1156 32 CP, Clear	2.1		24	18.20
9186-8563-30	Stepwell, W/Grnd Wire, #1156 32 CP, Clear	2.1		24	19.47
9186-8563-34	Stepwell, W/Grnd Wire, 24V, #1638 32 CP, Clear		1.01	24	24.26
9186-8564-30	Stepwell, Single Wire, #1141 21CP, Clear	1.9		24	18.09
9186-8565-30	Stepwell, W/Grnd Wire, #1141 21 CP, Clear	1.9		24	19.53
9186-8566-30	Stepwell (Special) Lamp, 50 CP, #1195, Clear	2.9		24	22.46
9186-8580-29	LED Turn/Marker, Amber	0.4/0.1		24	79.32
9187-9430-00	Siren w/PA, 200 Watts, Panel Mount, 6 Position, Rotary	17		4	868.60
9187-9500	Siren w/PA, 200 Watts, 4 Position	8		4	575.41
9188-1524L-00	24" Aero-Maxx II Lightbar, for split applications, left			1	2,226.00
9188-1524R-00	24" Aero-Maxx II Lightbar, for split applications, right			1	2,226.00
9188-1549-00	49" Aero-Maxx II Lightbar			1	2,653.00
9188-1554-00	54" Aero-Maxx II Lightbar			1	3,158.00
9188-1559-00	59" Aero-Maxx II Lightbar			1	3,445.00
9188-1572-00	72" Aero-Maxx II Lightbar			1	3,530.00
	Additional Lighthoods for Aero-Maxx II (each)			1	+263.00 each
	Alley Lights option for Aero-Maxx II Lightbar			1	+194.00 pair
	Take-Down Lights A-M II LB			1	+347.00 pair
	Traffic Director w/Controller 54" Lightbar (7 head)			1	+1,865.00 each
	Traffic Director w/Controller 59 or 72" Lightbar (8 head)			1	+2,137.00 each

**Converters**

MTM-2412	24-12 Converter Box				1,817.00
SCM-2412	24-12 Converter, Single Channel				376.00
SCM-2412K	Voltage Convertor Kit				416.00
UTM-2412	24-12 Connector and Converter Box, Universal Mounting				1,387.00

\* Amp Draw is variable and application dependent

\*\* Refer to individual lamps

Prices are for U.S. domestic resale and do not include International Tariffs, Taxes and Shipping

**NOTES:**



**In U.S./International  
Akron Brass Company  
P.O. Box 86 | Wooster, OH 44691  
PH: 330.264.5678 | Fax: 330.264.2944  
Toll Free: 800.228.1161  
Toll Free Fax: 800.531.7335  
E-Mail: [orders@akronbrass.com](mailto:orders@akronbrass.com)  
[www.akronbrass.com](http://www.akronbrass.com)**

**Weldon, a division of Akron Brass  
3656 Paragon Drive  
Columbus, Ohio 43228  
PH: 614.529.7230 | Fax: 614.527.3547  
Toll Free: 800.989.2718  
E-Mail: [orders@weldoninc.com](mailto:orders@weldoninc.com)  
[www.weldoninc.com](http://www.weldoninc.com)**

**Tested...  
Proven...  
Trusted.**

